

## Quad channel high-side driver with analog current sense for automotive applications

### Features

Max supply voltage	$V_{CC}$	41 V
Operating voltage range	$V_{CC}$	4.5 to 28 V
Max on-state resistance (per ch.)	$R_{ON}$	50 m $\Omega$
Current limitation (typ)	$I_{LIMH}$	27 A
Off-state supply current	$I_S$	2 $\mu$ A <sup>(1)</sup>

1. Typical value with all loads connected.

#### ■ General

- Inrush current active management by power limitation
- Very low standby current
- 3.0 V CMOS compatible inputs
- Optimized electromagnetic emissions
- Very low electromagnetic susceptibility
- Compliance with European directive 2002/95/EC
- Very low current sense leakage

#### ■ Diagnostic functions

- Proportional load current sense
- High current sense precision for wide currents range
- Current sense disable
- Off-state open-load detection
- Output short to  $V_{CC}$  detection
- Overload and short to ground (power limitation) indication
- Thermal shutdown indication

#### ■ Protections

- Undervoltage shutdown
- Overvoltage clamp
- Load current limitation
- Self limiting of fast thermal transients
- Protection against loss of ground and loss of  $V_{CC}$
- Overtemperature shutdown with auto restart (thermal shutdown)



- Reverse battery protected
- Electrostatic discharge protection

### Application

- All types of resistive, inductive and capacitive loads
- Suitable as LED driver

### Description

The VNQ5E050AK-E is a quad channel high-side driver manufactured using ST proprietary VIpower™ M0-5 technology and housed in PowerSSO-24 package. The device is designed to drive 12 V automotive grounded loads, and to provide protection and diagnostics. It also implements a 3 V and 5 V CMOS compatible interface for the use with any microcontroller.

The device integrates advanced protective functions such as load current limitation, inrush and overload active management by power limitation, overtemperature shut-off with auto-restart and overvoltage active clamp.

A dedicated analog current sense pin is associated with every output channel providing enhanced diagnostic functions including fast detection of overload and short-circuit to ground through power limitation indication, overtemperature indication, short-circuit to  $V_{CC}$  diagnosis and on-state and off-state open-load detection. The current sensing and diagnostic feedback of the whole device can be disabled by pulling the CS\_DIS pin high to share external sense resistor with similar devices.

# Contents

<b>1</b>	<b>Block diagram and pin configuration</b>	<b>5</b>
<b>2</b>	<b>Electrical specifications</b>	<b>7</b>
2.1	Absolute maximum ratings	7
2.2	Thermal data	8
2.3	Electrical characteristics	8
2.4	Waveforms	18
2.5	Electrical characteristics curves	21
<b>3</b>	<b>Application information</b>	<b>24</b>
3.1	GND protection network against reverse battery	24
3.1.1	Solution 1: resistor in the ground line (RGND only)	24
3.1.2	Solution 2: diode (DGND) in the ground line	25
3.2	Load dump protection	25
3.3	MCU I/Os protection	25
3.4	Current sense and diagnostic	26
3.4.1	Short to VCC and off-state open-load detection	27
3.5	Maximum demagnetization energy (VCC = 13.5 V)	28
<b>4</b>	<b>Package and PC board thermal data</b>	<b>29</b>
4.1	PowerSSO-24 thermal data	29
<b>5</b>	<b>Package and packing information</b>	<b>32</b>
5.1	ECOPACK®	32
5.2	PowerSSO-24 mechanical data	32
5.3	Packing information	34
<b>6</b>	<b>Order codes</b>	<b>35</b>
<b>7</b>	<b>Revision history</b>	<b>36</b>

## List of tables

Table 1.	Pin functions . . . . .	5
Table 2.	Suggested connections for unused and not connected pins . . . . .	6
Table 3.	Absolute maximum ratings . . . . .	7
Table 4.	Thermal data . . . . .	8
Table 5.	Power section . . . . .	8
Table 6.	Switching ( $V_{CC} = 13\text{ V}$ ; $T_j = 25\text{ }^\circ\text{C}$ ) . . . . .	9
Table 7.	Logic inputs . . . . .	9
Table 8.	Protections and diagnostics . . . . .	10
Table 9.	Current sense ( $8\text{ V} < V_{CC} < 18\text{ V}$ ) . . . . .	10
Table 10.	Open-load detection ( $8\text{V} < V_{CC} < 18\text{V}$ ) . . . . .	12
Table 11.	Truth table . . . . .	16
Table 12.	Electrical transient requirements (part 1) . . . . .	17
Table 13.	Electrical transient requirements (part 2) . . . . .	17
Table 14.	Electrical transient requirements (part 3) . . . . .	17
Table 15.	Thermal parameters . . . . .	31
Table 16.	PowerSSO-24 mechanical data . . . . .	33
Table 17.	Device summary . . . . .	35
Table 18.	Document revision history . . . . .	36



**SKYTECH**  
ELECTRONIC

## List of figures

Figure 1.	Block diagram	5
Figure 2.	Configuration diagram (top view)	6
Figure 3.	Current and voltage conventions	7
Figure 4.	Current sense delay characteristics	12
Figure 5.	Open-load off-state delay timing	13
Figure 6.	Switching characteristics	13
Figure 7.	Delay response time between rising edge of output current and rising edge of current sense (CS enabled)	14
Figure 8.	Output voltage drop limitation	14
Figure 9.	$I_{OUT}/I_{SENSE}$ vs $I_{OUT}$	15
Figure 10.	Maximum current sense ratio drift vs load current	15
Figure 11.	Normal operation	18
Figure 12.	Overload or short to GND	18
Figure 13.	Intermittent overload	19
Figure 14.	Off-state open-load with external circuitry	19
Figure 15.	Short to $V_{CC}$	20
Figure 16.	$T_j$ evolution in overload or short to GND	20
Figure 17.	Off-state output current	21
Figure 18.	High level input current	21
Figure 19.	Input clamp voltage	21
Figure 20.	Input low level	21
Figure 21.	Input high level	21
Figure 22.	Input hysteresis voltage	21
Figure 23.	On-state resistance vs $T_{case}$	22
Figure 24.	On-state resistance vs $V_{CC}$	22
Figure 25.	Undervoltage shutdown	22
Figure 26.	Turn-on voltage slope	22
Figure 27.	$I_{LIMH}$ vs $T_{case}$	22
Figure 28.	Turn-off voltage slope	22
Figure 29.	CS_DIS high level voltage	23
Figure 30.	CS_DIS clamp voltage	23
Figure 31.	CS_DIS low level voltage	23
Figure 32.	Application schematic	24
Figure 33.	Current sense and diagnostic	26
Figure 34.	Maximum turn-off current versus inductance (for each channel)	28
Figure 35.	PowerSSO-24 PC board	29
Figure 36.	$R_{thj-amb}$ vs PCB copper area in open box free air condition (one channel ON)	29
Figure 37.	PowerSSO-24 thermal impedance junction ambient single pulse (one channel ON)	30
Figure 38.	Thermal fitting model of a double channel HSD in PowerSSO-24	30
Figure 39.	PowerSSO-24 package dimensions	32
Figure 40.	PowerSSO-24 tube shipment (no suffix)	34
Figure 41.	PowerSSO-24 tape and reel shipment (suffix "TR")	34

# 1 Block diagram and pin configuration

Figure 1. Block diagram

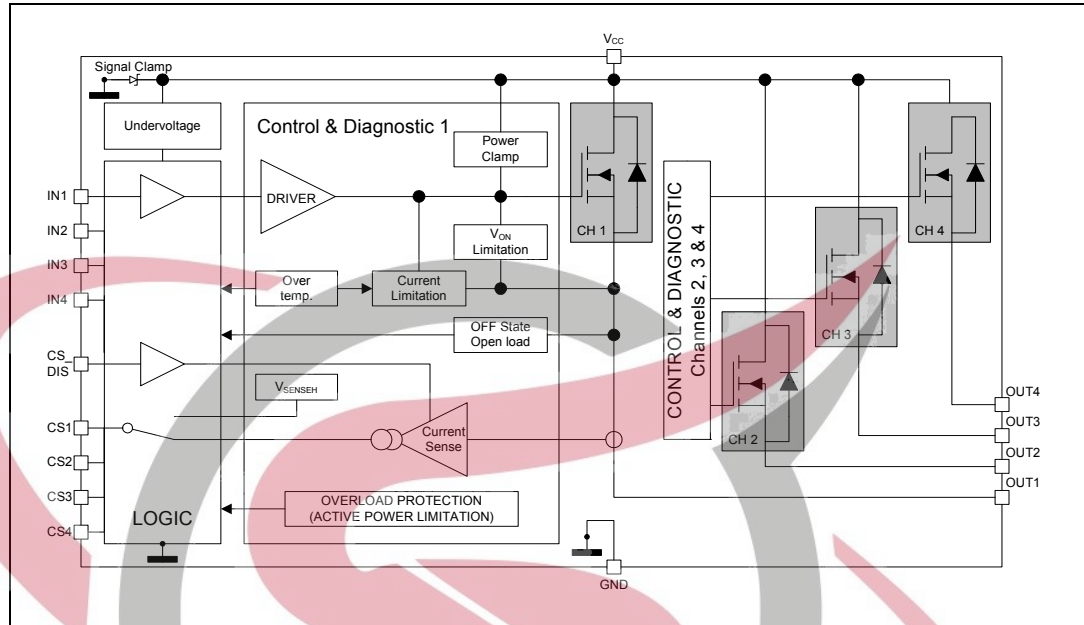

Table 1. Pin functions

Name	Function
V <sub>CC</sub>	Battery connection.
OUTPUT <sub>n</sub>	Power output.
GND	Ground connection. Must be reverse battery protected by an external diode/resistor network.
INPUT <sub>n</sub>	Voltage controlled input pin with hysteresis, CMOS compatible. Controls output switch state.
CURRENT SENSE <sub>n</sub>	Analog current sense pin, delivers a current proportional to the load current.
CS_DIS	Active high CMOS compatible pin, to disable the current sense pin.

Figure 2. Configuration diagram (top view)

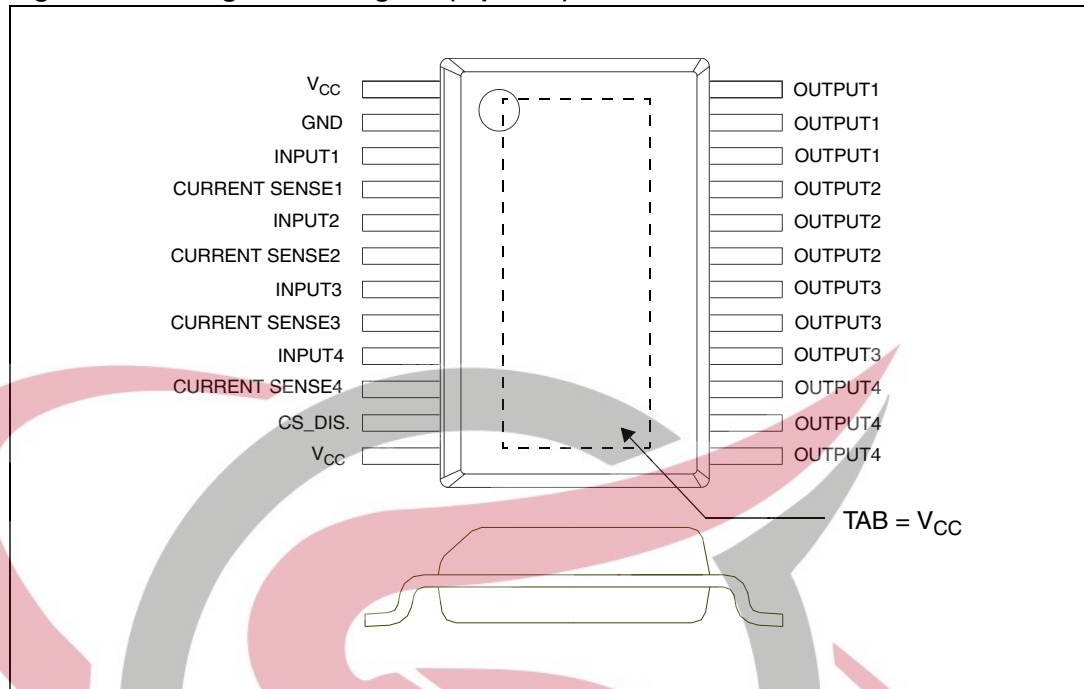

Table 2. Suggested connections for unused and not connected pins

Connection / pin	Current sense	N.C.	Output	Input	CS_DIS
Floating	Not allowed	X	X	X	X
To ground	Through 1 kΩ resistor	X	Through 22 kΩ resistor	Through 10 kΩ resistor	Through 10 kΩ resistor



## 2 Electrical specifications

Figure 3. Current and voltage conventions

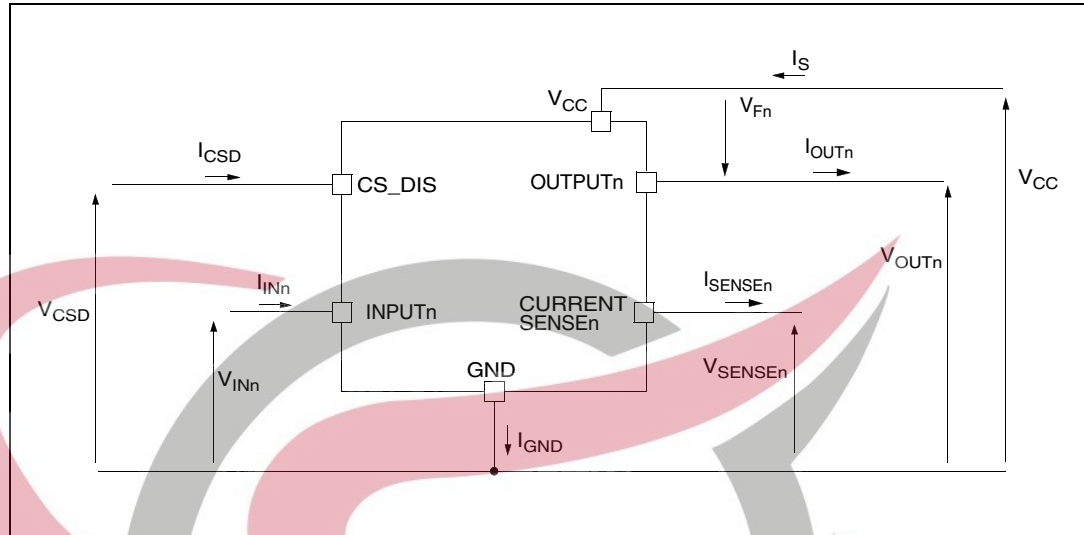

Note:  $V_{Fn} = V_{OUTn} - V_{CC}$  during reverse battery condition.

### 2.1 Absolute maximum ratings

Stressing the device above the ratings listed in the “Absolute maximum ratings” tables may cause permanent damage to the device. These are stress ratings only and operation of the device at these or any other conditions above those indicated in the operating sections of this specification is not implied. Exposure to the conditions reported in this section for extended periods may affect device reliability. Refer also to the STMicroelectronics SURE Program and other relevant quality documents.

Table 3. Absolute maximum ratings

Symbol	Parameter	Value	Unit
V <sub>CC</sub>	DC supply voltage	41	V
-V <sub>CC</sub>	Reverse DC supply voltage	0.3	V
-I <sub>GND</sub>	DC reverse ground pin current	200	mA
I <sub>OUT</sub>	DC output current	Internally limited	A
-I <sub>OUT</sub>	Reverse DC output current	20	A
I <sub>IN</sub>	DC input current	-1 to 10	mA
I <sub>CSD</sub>	DC current sense disable input current	-1 to 10	mA
-I <sub>CSSENSE</sub>	DC reverse CS pin current	200	mA
V <sub>CSSENSE</sub>	Current sense maximum voltage	V <sub>CC</sub> - 41 to +V <sub>CC</sub>	V

**Table 3. Absolute maximum ratings (continued)**

Symbol	Parameter	Value	Unit
$E_{MAX}$	Maximum switching energy (single pulse) ( $L = 3 \text{ mH}$ ; $R_L = 0 \text{ }\Omega$ ; $V_{bat} = 13.5 \text{ V}$ ; $T_{jstart} = 150 \text{ }^\circ\text{C}$ ; $I_{OUT} = I_{limL}(\text{Typ.})$ )	104	mJ
$V_{ESD}$	Electrostatic discharge (human body model: $R = 1.5 \text{ K}\Omega$ ; $C = 100 \text{ pF}$ )		
	– Input	4000	V
	– Current sense	2000	V
	– CS_DIS	4000	V
	– Output	5000	V
	– $V_{CC}$	5000	V
$V_{ESD}$	Charge device model (CDM-AEC-Q100-011)	750	V
$T_j$	Junction operating temperature	-40 to 150	$^\circ\text{C}$
$T_{stg}$	Storage temperature	-55 to 150	$^\circ\text{C}$

## 2.2 Thermal data

**Table 4. Thermal data**

Symbol	Parameter	Max. value	Unit
$R_{thj-case}$	Thermal resistance junction-case (with one channel ON)	2.8	$^\circ\text{C}/\text{W}$
$R_{thj-amb}$	Thermal resistance junction-ambient	See <a href="#">Figure 36</a>	$^\circ\text{C}/\text{W}$

## 2.3 Electrical characteristics

Values specified in this section are for  $8 \text{ V} < V_{CC} < 28 \text{ V}$ ,  $-40 \text{ }^\circ\text{C} < T_j < 150 \text{ }^\circ\text{C}$ , unless otherwise stated.

**Table 5. Power section**

Symbol	Parameter	Test conditions	Min.	Typ.	Max.	Unit
$V_{CC}$	Operating supply voltage		4.5	13	28	V
$V_{USD}$	Undervoltage shutdown		2.5	3.5	4.5	V
$V_{USDhyst}$	Undervoltage shutdown hysteresis			0.5		V
$R_{ON}$	On-state resistance <sup>(1)</sup>	$I_{OUT} = 2 \text{ A}$ ; $T_j = 25 \text{ }^\circ\text{C}$			50	m $\Omega$
		$I_{OUT} = 2 \text{ A}$ ; $T_j = 150 \text{ }^\circ\text{C}$			100	
		$I_{OUT} = 2 \text{ A}$ ; $V_{CC} = 5 \text{ V}$ ; $T_j = 25 \text{ }^\circ\text{C}$			65	
$V_{clamp}$	Clamp voltage	$I_S = 20 \text{ mA}$	41	46	52	V



Table 5. Power section (continued)

Symbol	Parameter	Test conditions	Min.	Typ.	Max.	Unit
$I_S$	Supply current	Off-state; $V_{CC} = 13\text{ V}$ ; $T_j = 25\text{ }^\circ\text{C}$ ; $V_{IN} = V_{OUT} = V_{SENSE} = V_{CSD} = 0\text{ V}$		2 <sup>(2)</sup>	5 <sup>(2)</sup>	$\mu\text{A}$
		On-state; $V_{CC} = 13\text{ V}$ ; $V_{IN} = 5\text{ V}$ ; $I_{OUT} = 0\text{ A}$		8	14	$\text{mA}$
$I_{L(off)}$	Off-state output current <sup>(1)</sup>	$V_{IN} = V_{OUT} = 0\text{ V}$ ; $V_{CC} = 13\text{ V}$ ; $T_j = 25\text{ }^\circ\text{C}$	0	0.01	3	$\mu\text{A}$
		$V_{IN} = V_{OUT} = 0\text{ V}$ ; $V_{CC} = 13\text{ V}$ ; $T_j = 125\text{ }^\circ\text{C}$	0		5	
$V_F$	Output - $V_{CC}$ diode voltage <sup>(1)</sup>	$-I_{OUT} = 2\text{ A}$ ; $T_j = 150\text{ }^\circ\text{C}$			0.7	$\text{V}$

1. For each channel

2. PowerMOS leakage included.

Table 6. Switching ( $V_{CC} = 13\text{ V}$ ;  $T_j = 25\text{ }^\circ\text{C}$ )

Symbol	Parameter	Test conditions	Min.	Typ.	Max.	Unit
$t_{d(on)}$	Turn-on delay time	$R_L = 6.5\ \Omega$ (see <a href="#">Figure 6.</a> )		20		$\mu\text{s}$
$t_{d(off)}$	Turn-off delay time	$R_L = 6.5\ \Omega$ (see <a href="#">Figure 6.</a> )		35		$\mu\text{s}$
$(dV_{OUT}/dt)_{on}$	Turn-on voltage slope	$R_L = 6.5\ \Omega$		See <a href="#">Figure 26</a>		$\text{V}/\mu\text{s}$
$(dV_{OUT}/dt)_{off}$	Turn-off voltage slope	$R_L = 6.5\ \Omega$		See <a href="#">Figure 28</a>		$\text{V}/\mu\text{s}$
$W_{ON}$	Switching energy losses during $t_{won}$	$R_L = 6.5\ \Omega$ (see <a href="#">Figure 6.</a> )		0.15		$\text{mJ}$
$W_{OFF}$	Switching energy losses during $t_{woff}$	$R_L = 6.5\ \Omega$ (see <a href="#">Figure 6.</a> )		0.25		$\text{mJ}$

Table 7. Logic inputs

Symbol	Parameter	Test conditions	Min.	Typ.	Max.	Unit
$V_{IL}$	Input low level voltage				0.9	$\text{V}$
$I_{IL}$	Low level input current	$V_{IN} = 0.9\text{ V}$	1			$\mu\text{A}$
$V_{IH}$	Input high level voltage		2.1			$\text{V}$
$I_{IH}$	High level input current	$V_{IN} = 2.1\text{ V}$			10	$\mu\text{A}$
$V_{I(hyst)}$	Input hysteresis voltage		0.25			$\text{V}$
$V_{ICL}$	Input clamp voltage	$I_{IN} = 1\text{ mA}$	5.5		7	$\text{V}$
		$I_{IN} = -1\text{ mA}$		-0.7		
$V_{CSDL}$	CS_DIS low level voltage				0.9	$\text{V}$
$I_{CSDL}$	Low level CS_DIS current	$V_{CSD} = 0.9\text{ V}$	1			$\mu\text{A}$
$V_{CSDH}$	CS_DIS high level voltage		2.1			$\text{V}$

**Table 7. Logic inputs (continued)**

Symbol	Parameter	Test conditions	Min.	Typ.	Max.	Unit
$I_{CSDH}$	High level CS_DIS current	$V_{CSD} = 2.1\text{ V}$			10	$\mu\text{A}$
$V_{CSD(hyst)}$	CS_DIS hysteresis voltage		0.25			V
$V_{CSCL}$	CS_DIS clamp voltage	$I_{CSD} = 1\text{ mA}$	5.5		7	V
		$I_{CSD} = -1\text{ mA}$		-0.7		

**Table 8. Protections and diagnostics (1)**

Symbol	Parameter	Test conditions	Min.	Typ.	Max.	Unit
$I_{limH}$	DC short circuit current	$V_{CC} = 13\text{ V}$	19	27	38	A
		$5\text{ V} < V_{CC} < 28\text{ V}$			38	A
$I_{limL}$	Short circuit current during thermal cycling	$V_{CC} = 13\text{ V}; T_R < T_j < T_{TSD}$		7		A
$T_{TSD}$	Shutdown temperature		150	175	200	$^{\circ}\text{C}$
$T_R$	Reset temperature		$T_{RS} + 1$	$T_{RS} + 5$		$^{\circ}\text{C}$
$T_{RS}$	Thermal reset of STATUS		135			$^{\circ}\text{C}$
$T_{HYST}$	Thermal hysteresis ( $T_{TSD} - T_R$ )			7		$^{\circ}\text{C}$
$V_{DEMAG}$	Turn-off output voltage clamp	$I_{OUT} = 2\text{ A}; V_{IN} = 0;$ $L = 6\text{ mH}$	$V_{CC} - 41$	$V_{CC} - 46$	$V_{CC} - 52$	V
$V_{ON}$	Output voltage drop limitation	$I_{OUT} = 0.1\text{ A};$ $T_j = -40\text{ }^{\circ}\text{C} \dots 150\text{ }^{\circ}\text{C}$ (see Figure 8)		25		mV

1. To ensure long term reliability under heavy overload or short circuit conditions, protection and related diagnostic signals must be used together with a proper software strategy. If the device is subjected to abnormal conditions, this software must limit the duration and number of activation cycles.

**Table 9. Current sense (8 V < V<sub>CC</sub> < 18 V)**

Symbol	Parameter	Test conditions	Min.	Typ.	Max.	Unit
$K_0$	$I_{OUT}/I_{SENSE}$	$I_{OUT} = 0.05\text{ A};$ $V_{SENSE} = 0.5\text{ V}; V_{CSD} = 0\text{ V};$ $T_j = -40\text{ }^{\circ}\text{C} \dots 150\text{ }^{\circ}\text{C}$	1050	2110	3170	
$K_1$	$I_{OUT}/I_{SENSE}$	$I_{OUT} = 1\text{ A};$ $V_{SENSE} = 4\text{ V}; V_{CSD} = 0\text{ V};$ $T_j = -40\text{ }^{\circ}\text{C} \dots 150\text{ }^{\circ}\text{C}$	1510	1890	2650	
		$T_j = 25\text{ }^{\circ}\text{C} \dots 150\text{ }^{\circ}\text{C}$	1510	1890	2270	
$dK_1/K_1^{(1)}$	Current sense ratio drift	$I_{OUT} = 1\text{ A}; V_{SENSE} = 4\text{ V};$ $V_{CSD} = 0\text{ V};$ $T_j = -40\text{ }^{\circ}\text{C} \text{ to } 150\text{ }^{\circ}\text{C}$	-13		13	%

Table 9. Current sense ( $8\text{ V} < V_{CC} < 18\text{ V}$ ) (continued)

Symbol	Parameter	Test conditions	Min.	Typ.	Max.	Unit
$K_2$	$I_{OUT}/I_{SENSE}$	$I_{OUT} = 2\text{ A}$ ; $V_{SENSE} = 4\text{ V}$ ; $V_{CSD} = 0\text{ V}$ ; $T_j = -40\text{ }^\circ\text{C} \dots 150\text{ }^\circ\text{C}$ $T_j = 25\text{ }^\circ\text{C} \dots 150\text{ }^\circ\text{C}$	1600 1600	1800 1800	2230 2000	
$dK_2/K_2^{(1)}$	Current sense ratio drift	$I_{OUT} = 2\text{ A}$ ; $V_{SENSE} = 4\text{ V}$ ; $V_{CSD} = 0\text{ V}$ ; $T_j = -40\text{ }^\circ\text{C}$ to $150\text{ }^\circ\text{C}$	-8		8	%
$K_3$	$I_{OUT}/I_{SENSE}$	$I_{OUT} = 4\text{ A}$ ; $V_{SENSE} = 4\text{ V}$ ; $V_{CSD} = 0\text{ V}$ ; $T_j = -40\text{ }^\circ\text{C} \dots 150\text{ }^\circ\text{C}$ $T_j = 25\text{ }^\circ\text{C} \dots 150\text{ }^\circ\text{C}$	1620 1620	1770 1770	1990 1920	
$dK_3/K_3^{(1)}$	Current sense ratio drift	$I_{OUT} = 4\text{ A}$ ; $V_{SENSE} = 4\text{ V}$ ; $V_{CSD} = 0\text{ V}$ ; $T_j = -40\text{ }^\circ\text{C}$ to $150\text{ }^\circ\text{C}$	-6		6	%
$I_{SENSE0}$	Analog sense leakage current	$I_{OUT} = 0\text{ A}$ ; $V_{SENSE} = 0\text{ V}$ ; $V_{CSD} = 5\text{ V}$ ; $V_{IN} = 0\text{ V}$ ; $T_j = -40\text{ }^\circ\text{C} \dots 150\text{ }^\circ\text{C}$	0		1	$\mu\text{A}$
		$I_{OUT} = 0\text{ A}$ ; $V_{SENSE} = 0\text{ V}$ ; $V_{CSD} = 0\text{ V}$ ; $V_{IN} = 5\text{ V}$ ; $T_j = -40\text{ }^\circ\text{C} \dots 150\text{ }^\circ\text{C}$	0		2	
		$I_{OUT} = 2\text{ A}$ ; $V_{SENSE} = 0\text{ V}$ ; $V_{CSD} = 5\text{ V}$ ; $V_{IN} = 5\text{ V}$ ; $T_j = -40\text{ }^\circ\text{C} \dots 150\text{ }^\circ\text{C}$	0		1	
$I_{OL}$	Open-load on-state current detection threshold	$V_{IN} = 5\text{ V}$ ; $8\text{ V} < V_{CC} < 18\text{ V}$ ; $I_{SENSE} = 5\text{ } \mu\text{A}$	4		20	$\text{mA}$
$V_{SENSE}$	Max analog sense output voltage	$I_{OUT} = 4\text{ A}$ ; $V_{CSD} = 0\text{ V}$	5			$\text{V}$
$V_{SENSEH}$	Analog sense output voltage in fault condition <sup>(2)</sup>	$V_{CC} = 13\text{ V}$ ; $R_{SENSE} = 10\text{ k}\Omega$		8		$\text{V}$
$I_{SENSEH}$	Analog sense output current in fault condition <sup>(2)</sup>	$V_{CC} = 13\text{ V}$ ; $V_{SENSE} = 5\text{ V}$		9		$\text{mA}$
$t_{DSENSE1H}$	Delay response time from falling edge of CS_DIS pin	$V_{SENSE} < 4\text{ V}$ , $0.5\text{ A} < I_{OUT} < 4\text{ A}$ $I_{SENSE} = 90\%$ of $I_{SENSEMAX}$ (see <a href="#">Figure 4</a> )		40	100	$\mu\text{s}$
$t_{DSENSE1L}$	Delay response time from rising edge of CS_DIS pin	$V_{SENSE} < 4\text{ V}$ ; $0.5\text{ A} < I_{OUT} < 4\text{ A}$ $I_{SENSE} = 10\%$ of $I_{SENSEMAX}$ (see <a href="#">Figure 4</a> )		5	20	$\mu\text{s}$
$t_{DSENSE2H}$	Delay response time from rising edge of INPUT pin	$V_{SENSE} < 4\text{ V}$ , $0.5\text{ A} < I_{OUT} < 4\text{ A}$ $I_{SENSE} = 90\%$ of $I_{SENSEMAX}$ (see <a href="#">Figure 4</a> )		80	250	$\mu\text{s}$

**Table 9. Current sense (8 V < V<sub>CC</sub> < 18 V) (continued)**

Symbol	Parameter	Test conditions	Min.	Typ.	Max.	Unit
$\Delta t_{DSENSE2H}$	Delay response time between rising edge of output current and rising edge of current sense	$V_{SENSE} < 4\text{ V}$ , $I_{SENSE} = 90\%$ of $I_{SENSEMAX}$ , $I_{OUT} = 90\%$ of $I_{OUTMAX}$ $I_{OUTMAX} = 2\text{ A}$ (see <a href="#">Figure 7</a> )			60	$\mu\text{s}$
$t_{DSENSE2L}$	Delay response time from falling edge of INPUT pin	$V_{SENSE} < 4\text{ V}$ , $0.5\text{ A} < I_{OUT} < 4\text{ A}$ $I_{SENSE} = 10\%$ of $I_{SENSEMAX}$ (see <a href="#">Figure 4</a> )		80	250	$\mu\text{s}$

- Parameter guaranteed by design; it is not tested.
- Fault condition includes: power limitation, overtemperature and open-load off-state detection.

**Table 10. Open-load detection (8V<V<sub>CC</sub><18V)**

Symbol	Parameter	Test conditions	Min.	Typ.	Max.	Unit
$V_{OL}$	Open-load off-state voltage detection threshold	$V_{IN} = 0\text{ V}$	2	See <a href="#">Figure 5</a>	4	V
$t_{DSTKON}$	Output short circuit to V <sub>cc</sub> detection delay at turn-off	See <a href="#">Figure 5</a>	180		1200	$\mu\text{s}$
$I_{L(off2)r}$	Off-state output current at $V_{OUT} = 4\text{ V}$	$V_{IN} = 0\text{ V}$ ; $V_{SENSE} = 0\text{ V}$ ; $V_{OUT}$ rising from 0 V to 4 V	-120		0	$\mu\text{A}$
$I_{L(off2)f}$	Off-state output current at $V_{OUT} = 2\text{ V}$	$V_{IN} = 0\text{ V}$ ; $V_{SENSE} = V_{SENSEH}$ $V_{OUT}$ falling from $V_{CC}$ to 2 V	-50		90	$\mu\text{A}$
$td\_vol$	Delay response from output rising edge to $V_{SENSE}$ rising edge in open-load	$V_{OUT} = 4\text{ V}$ ; $V_{IN} = 0\text{ V}$ $V_{SENSE} = 90\%$ of $V_{SENSEH}$			20	$\mu\text{s}$

**Figure 4. Current sense delay characteristics**

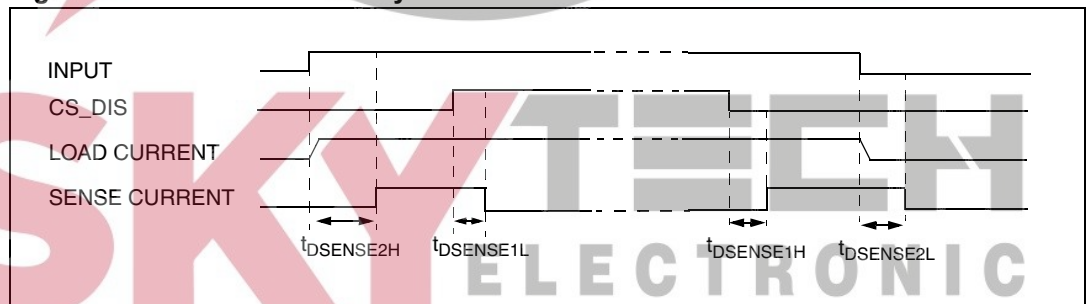

Figure 5. Open-load off-state delay timing

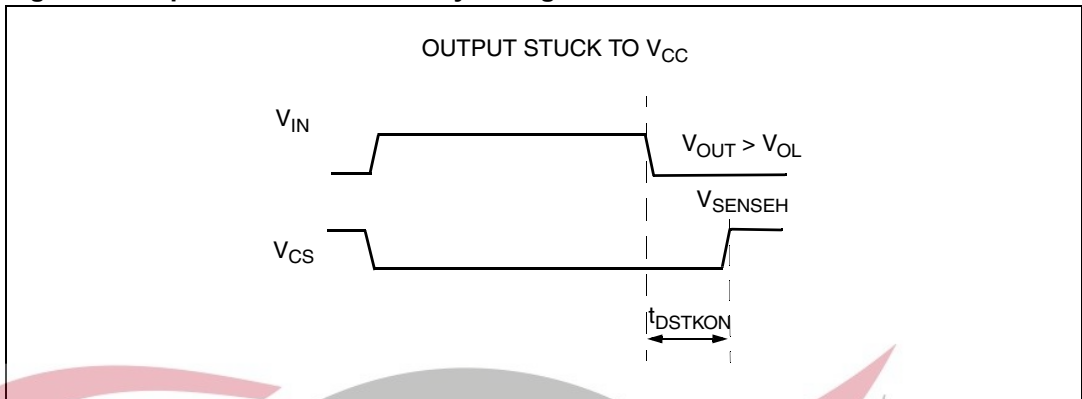
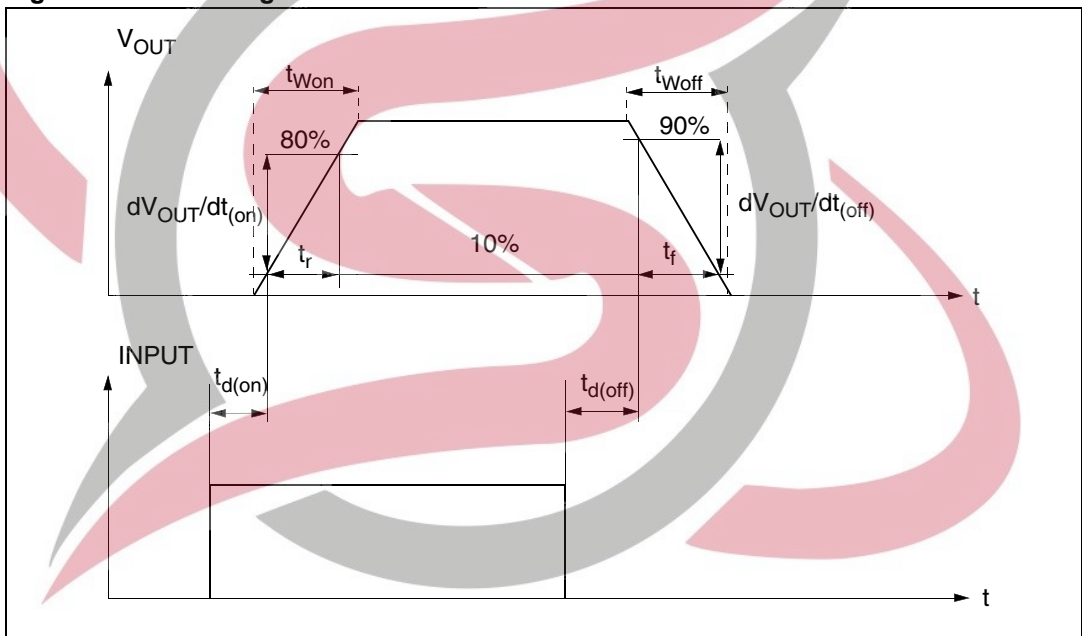

Figure 6. Switching characteristics



**SKY**TECH  
ELECTRONIC

Figure 7. Delay response time between rising edge of output current and rising edge of current sense (CS enabled)

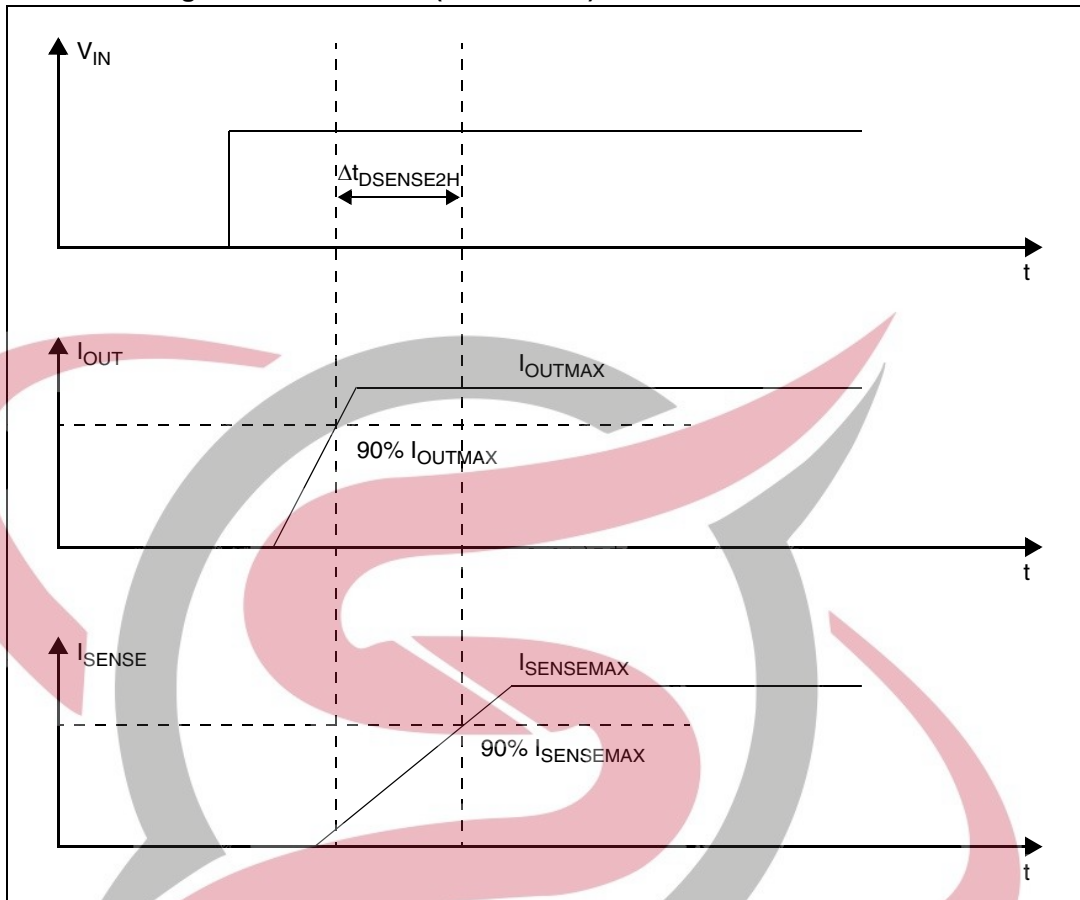

Figure 8. Output voltage drop limitation

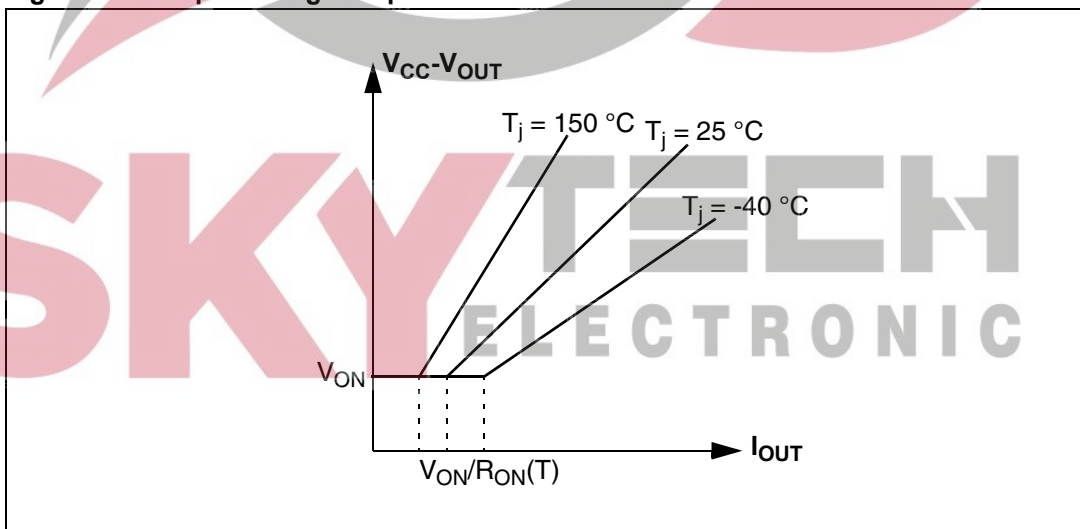

Figure 9.  $I_{OUT}/I_{SENSE}$  vs  $I_{OUT}$

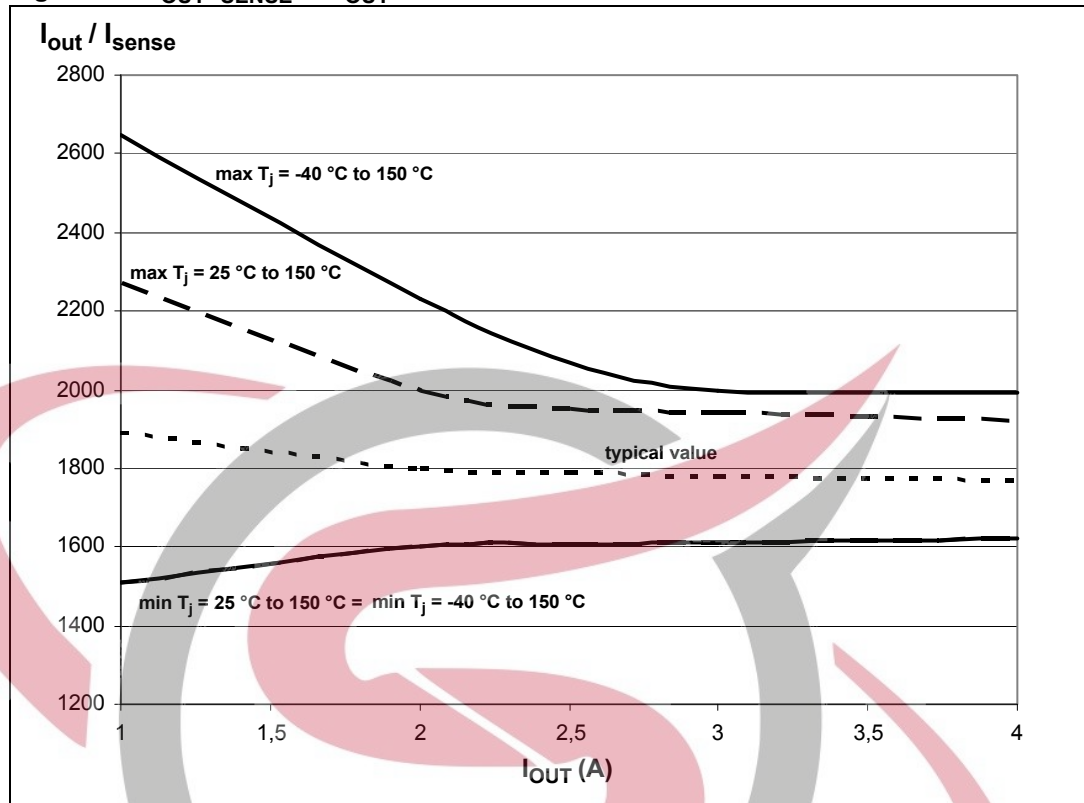
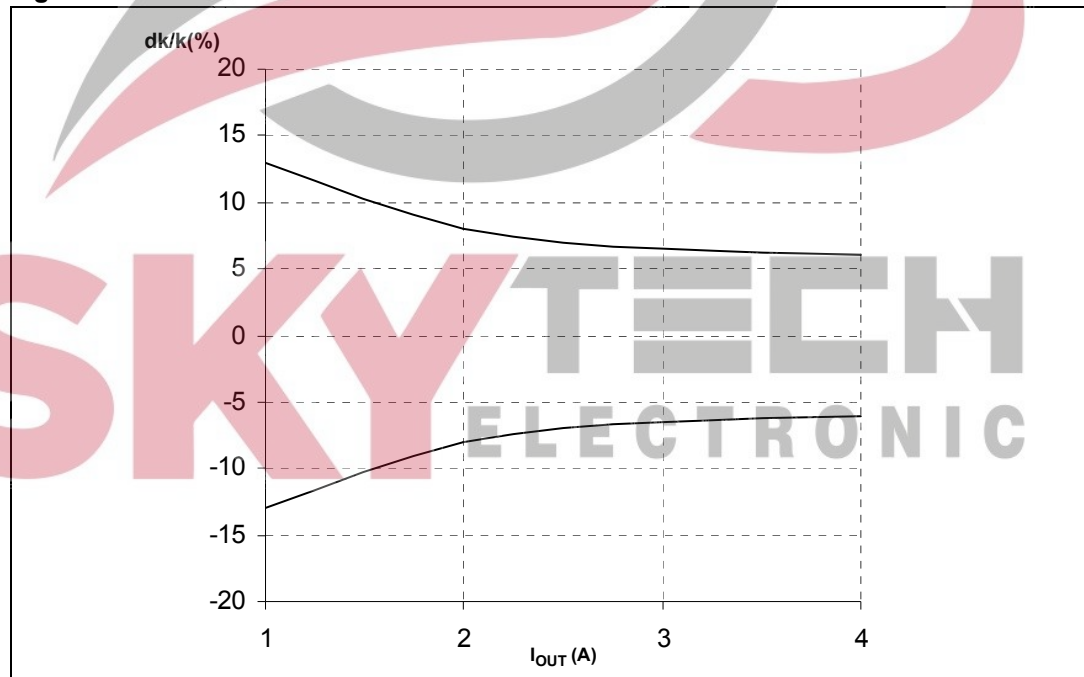

Figure 10. Maximum current sense ratio drift vs load current



Note: Parameter guaranteed by design; it is not tested.

**Table 11. Truth table**

Conditions	Input	Output	Sense ( $V_{CSD} = 0\text{ V}$ ) <sup>(1)</sup>
Normal operation	L	L	0
	H	H	Nominal
Overtemperature	L	L	0
	H	L	$V_{SENSEH}$
Undervoltage	L	L	0
	H	L	0
Overload	H	X	Nominal
	H	(no power limitation)	$V_{SENSEH}$
		Cycling (power limitation)	
Short circuit to GND (power limitation)	L	L	0
	H	L	$V_{SENSEH}$
Open-load off-state (with external pull-up)	L	H	$V_{SENSEH}$
Short circuit to $V_{CC}$ (external pull-up disconnected)	L	H	$V_{SENSEH}$
	H	H	< Nominal
Negative output voltage clamp	L	L	0

1. If the  $V_{CSD}$  is high, the SENSE output is at a high impedance, its potential depends on leakage currents and external circuit.





**Table 12. Electrical transient requirements (part 1)**

ISO 7637-2: 2004(E) Test pulse	Test levels <sup>(1)</sup>		Number of pulses or test times	Burst cycle/pulse repetition time		Delays and impedance
	III	IV		Min.	Max.	
1	-75V	-100V	5000 pulses	0.5s	5s	2 ms, 10Ω
2a	+37V	+50V	5000 pulses	0.2s	5s	50μs, 2Ω
3a	-100V	-150V	1h	90ms	100ms	0.1μs, 50Ω
3b	+75V	+100V	1h	90ms	100ms	0.1μs, 50Ω
4	-6V	-7V	1 pulse			100ms, 0.01Ω
5b <sup>(2)</sup>	+65V	+87V	1 pulse			400ms, 2Ω

1. The above test levels must be considered referred to  $V_{CC} = 13.5V$  except for pulse 5b.
2. Valid in case of external load dump clamp: 40V maximum referred to ground.

**Table 13. Electrical transient requirements (part 2)**

ISO 7637-2: 2004E Test pulse	Test level results	
	III	VI
1	C	C
2a	C	C
3a	C	C
3b	C	C
4	C	C
5b <sup>(1)</sup>	C	C

1. Valid in case of external load dump clamp: 40V maximum referred to ground.

**Table 14. Electrical transient requirements (part 3)**

Class	Contents
C	All functions of the device performed as designed after exposure to disturbance.
E	One or more functions of the device did not perform as designed after exposure to disturbance and cannot be returned to proper operation without replacing the device.

## 2.4 Waveforms

Figure 11. Normal operation

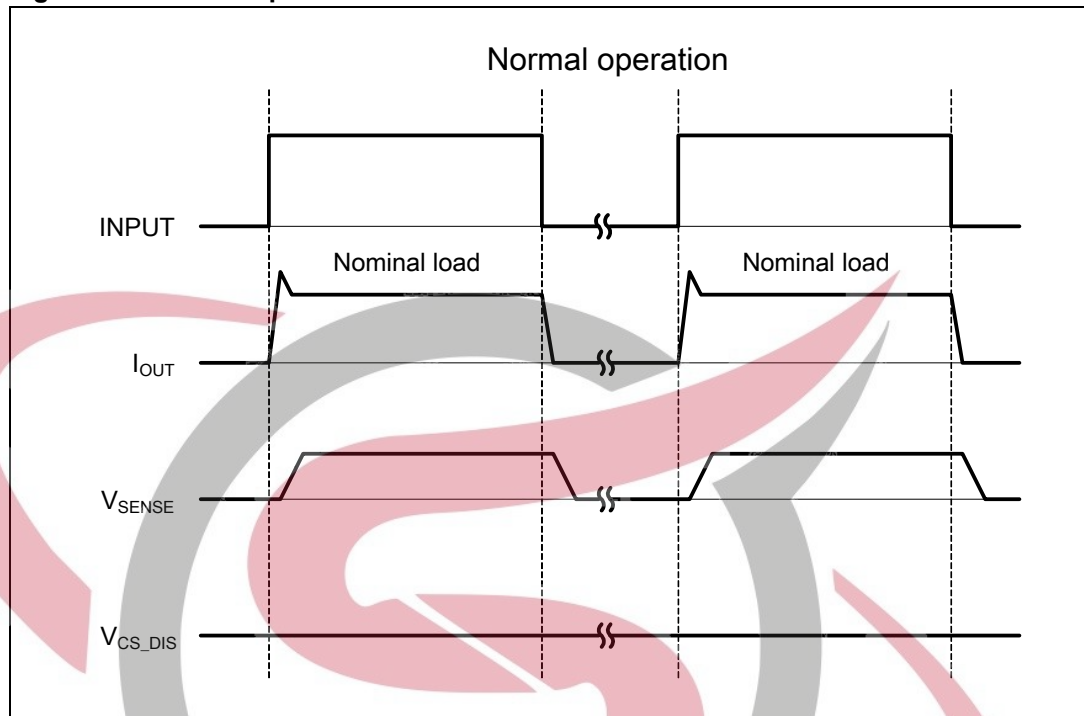

Figure 12. Overload or short to GND

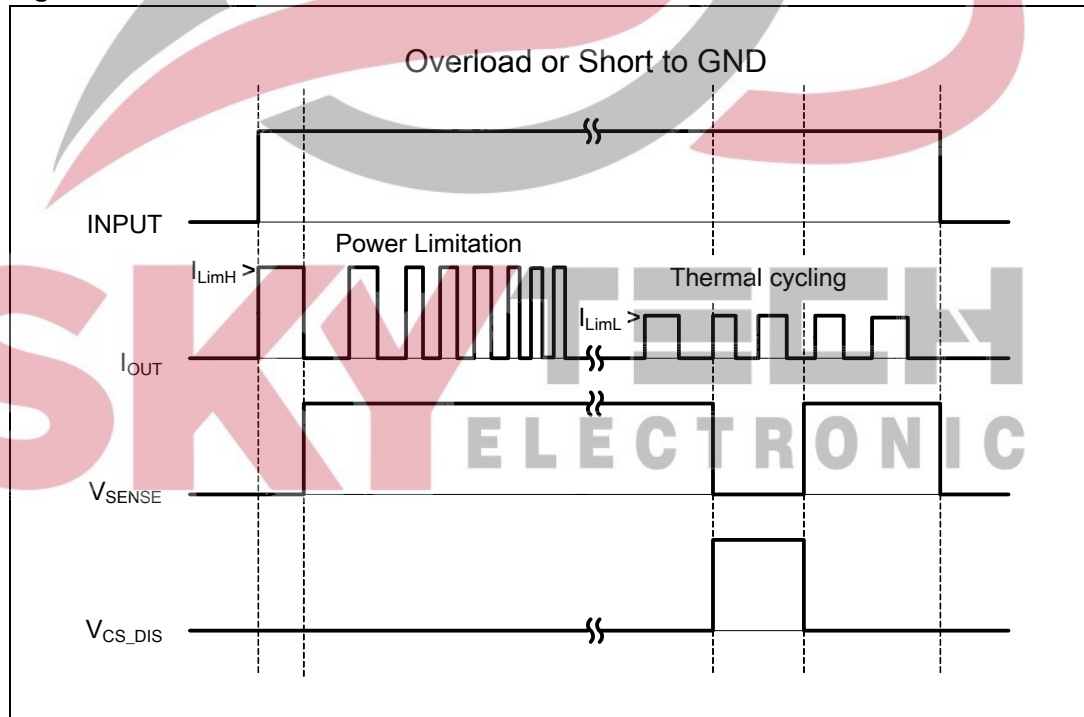

Figure 13. Intermittent overload

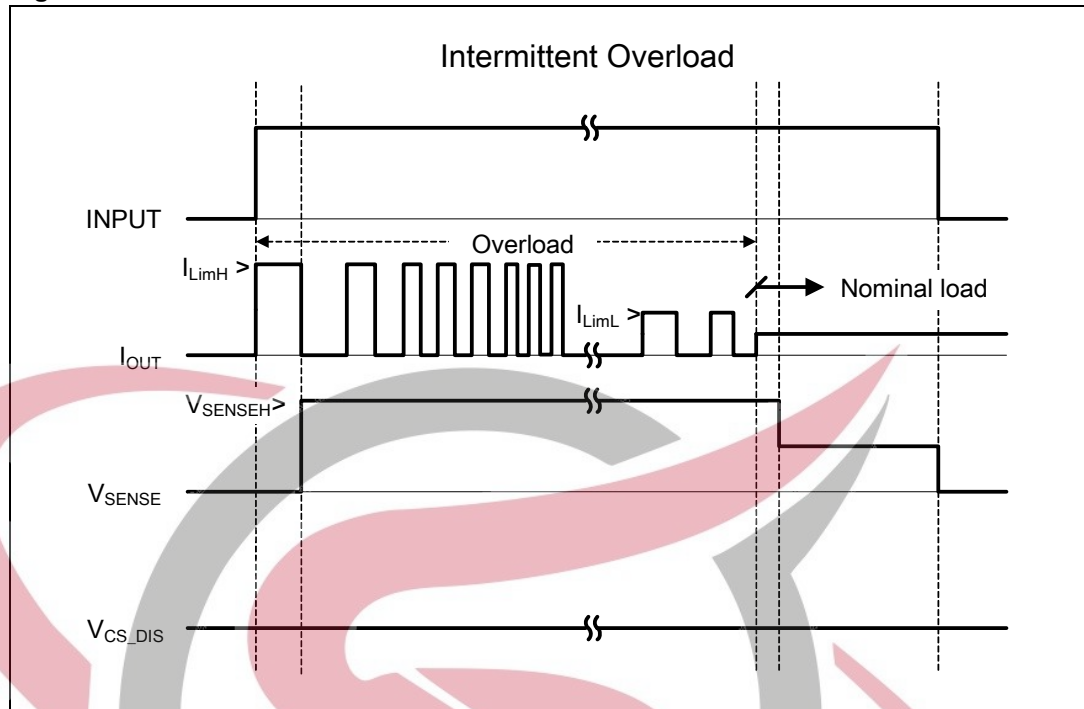

Figure 14. Off-state open-load with external circuitry

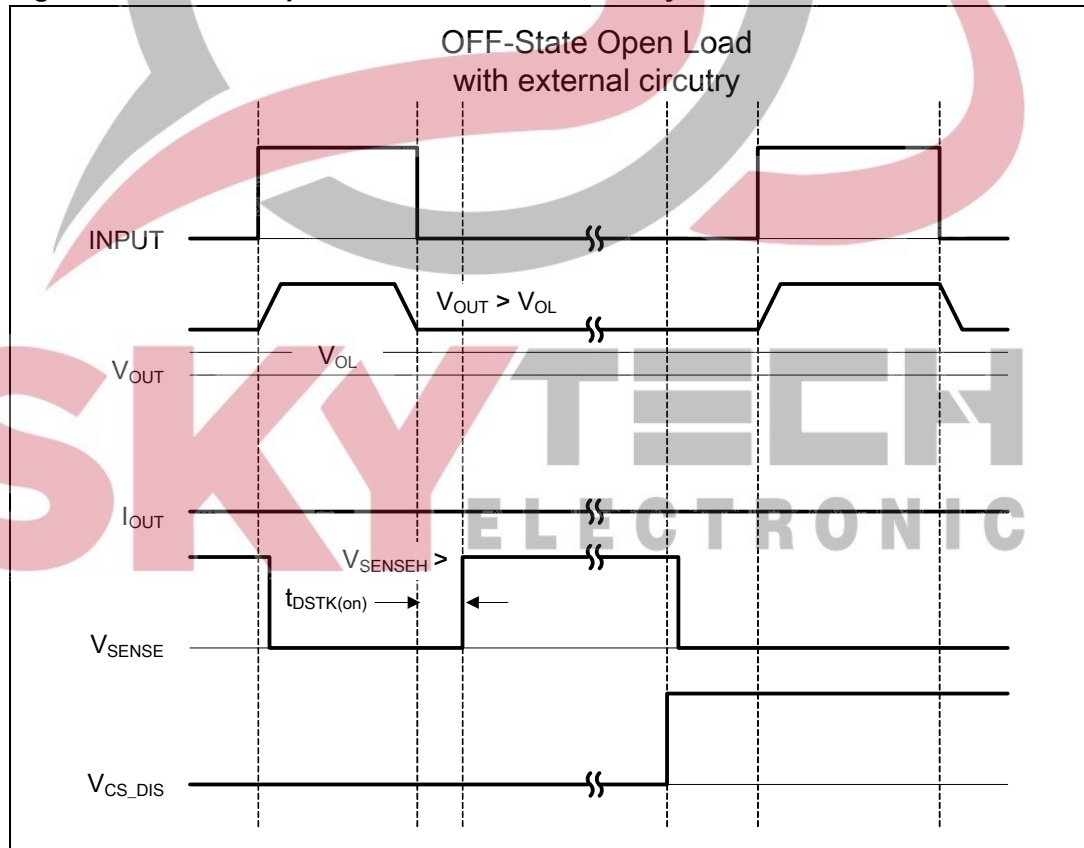

Figure 15. Short to V<sub>CC</sub>

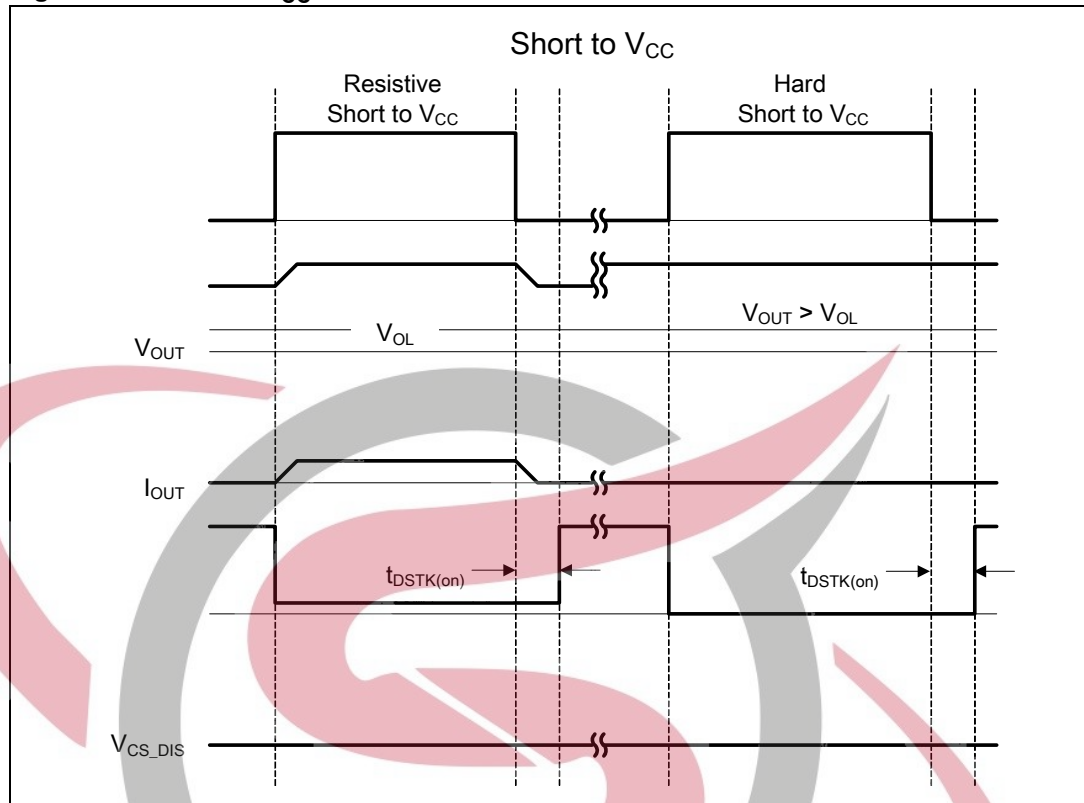
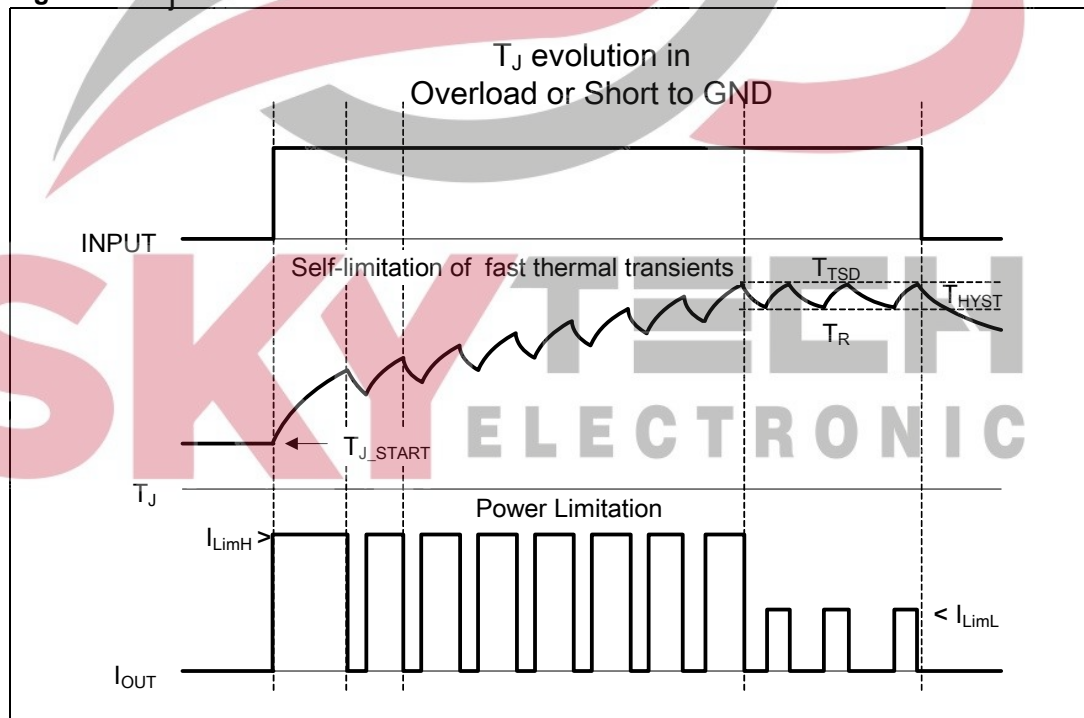

Figure 16. T<sub>J</sub> evolution in overload or short to GND



## 2.5 Electrical characteristics curves

Figure 17. Off-state output current

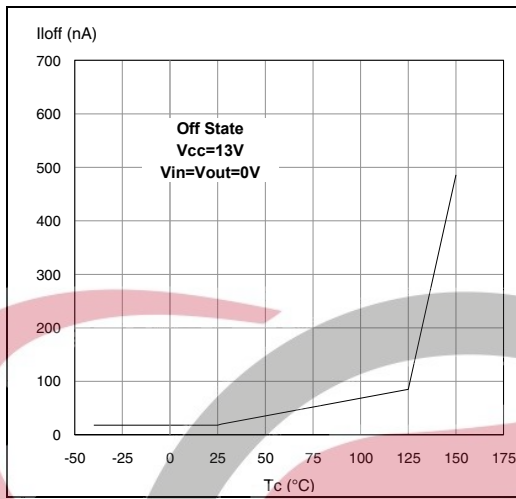

Figure 18. High level input current

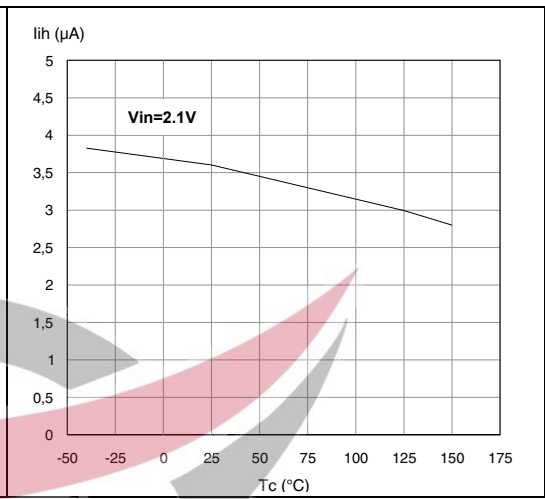

Figure 19. Input clamp voltage

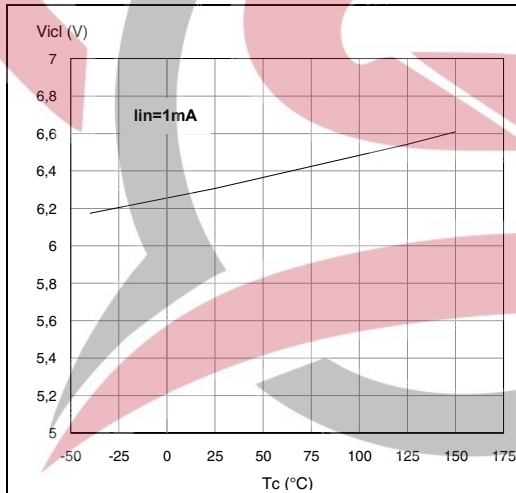

Figure 20. Input low level

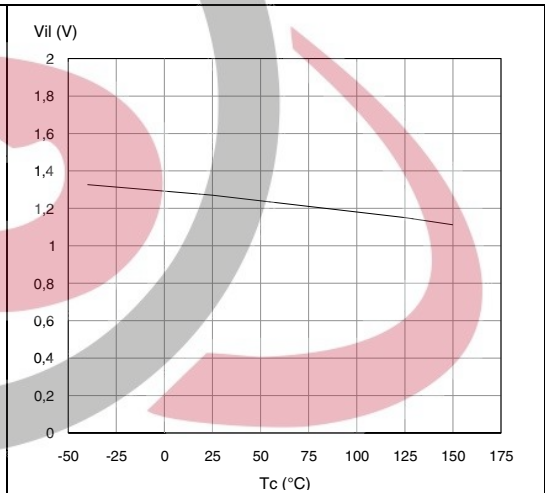

Figure 21. Input high level

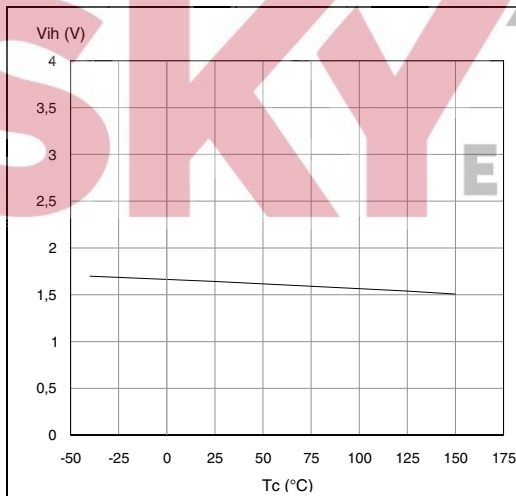

Figure 22. Input hysteresis voltage

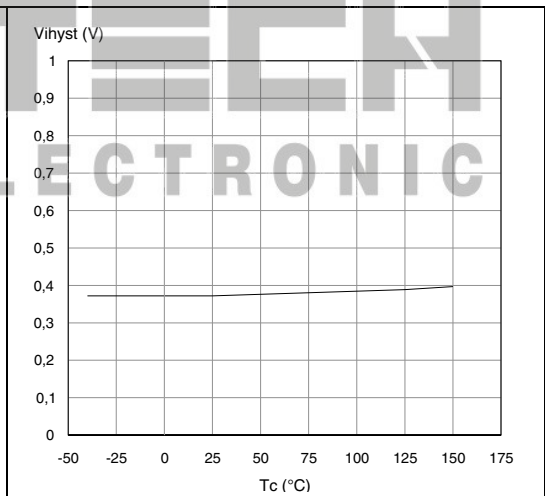

Figure 23. On-state resistance vs  $T_{case}$

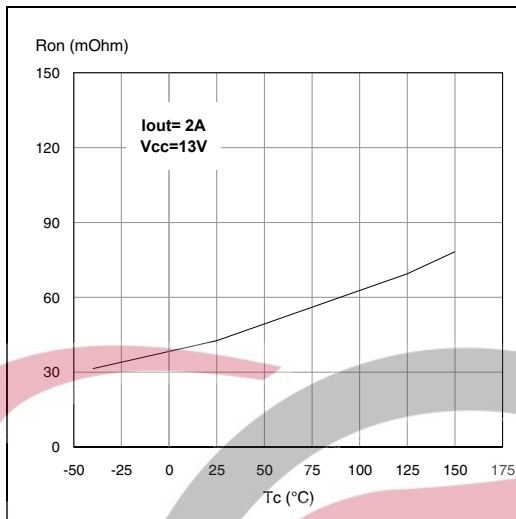

Figure 24. On-state resistance vs  $V_{CC}$

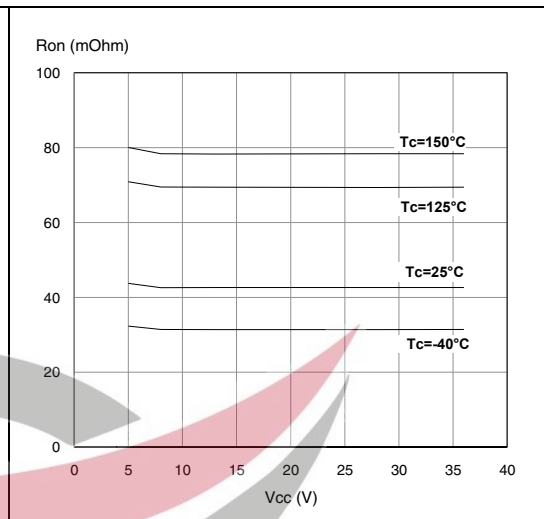

Figure 25. Undervoltage shutdown

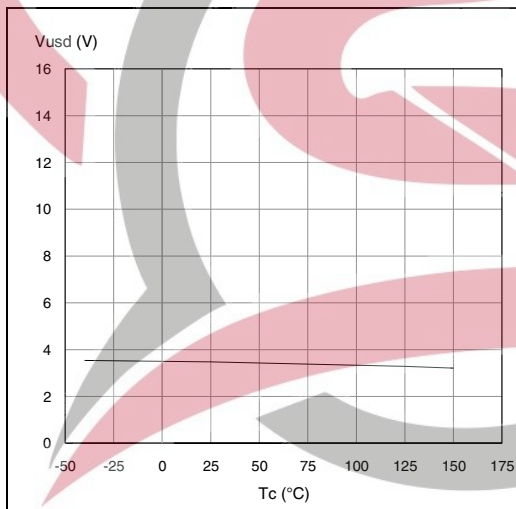

Figure 26. Turn-on voltage slope

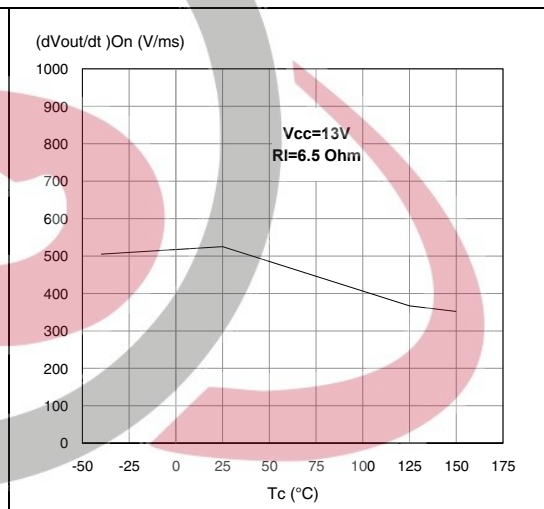

Figure 27.  $I_{LIMH}$  vs  $T_{case}$

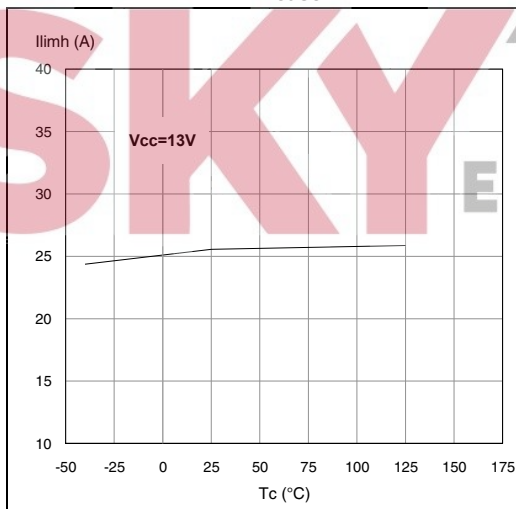

Figure 28. Turn-off voltage slope

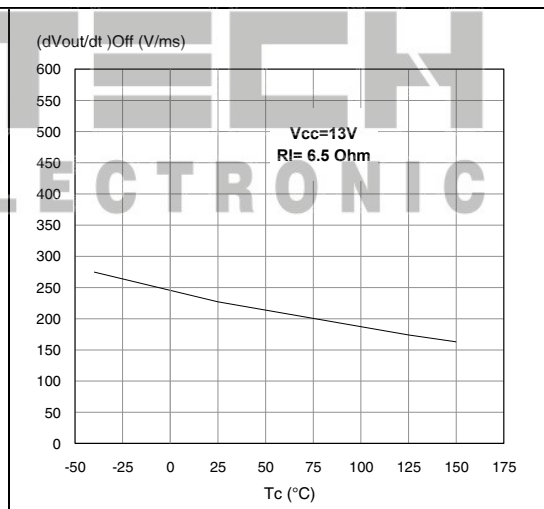

Figure 29. CS\_DIS high level voltage

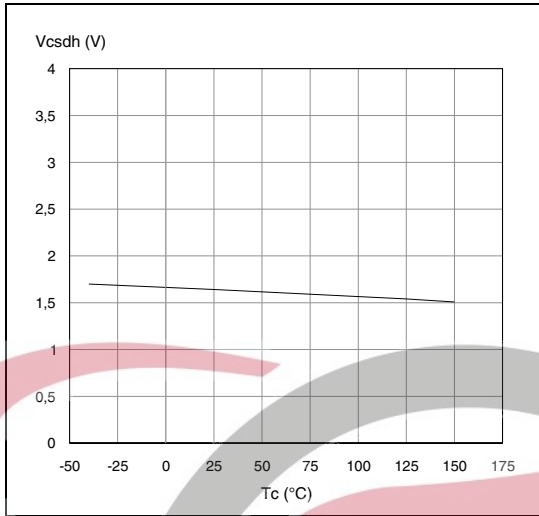

Figure 30. CS\_DIS clamp voltage

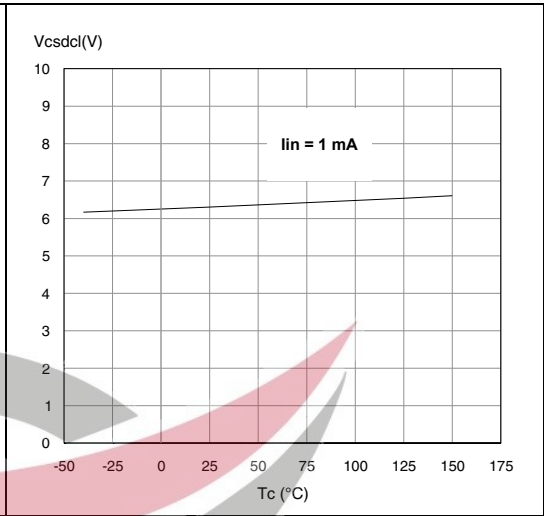
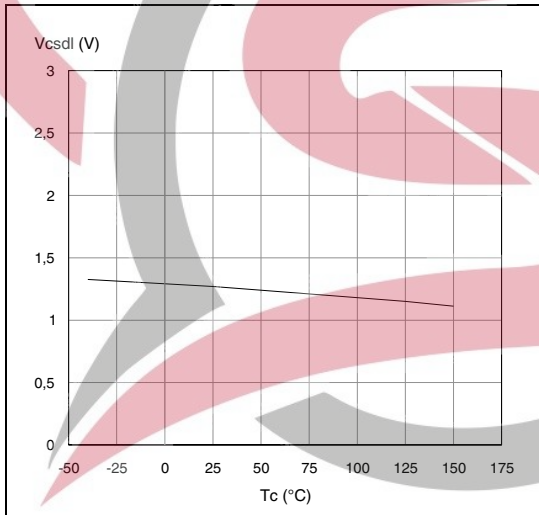
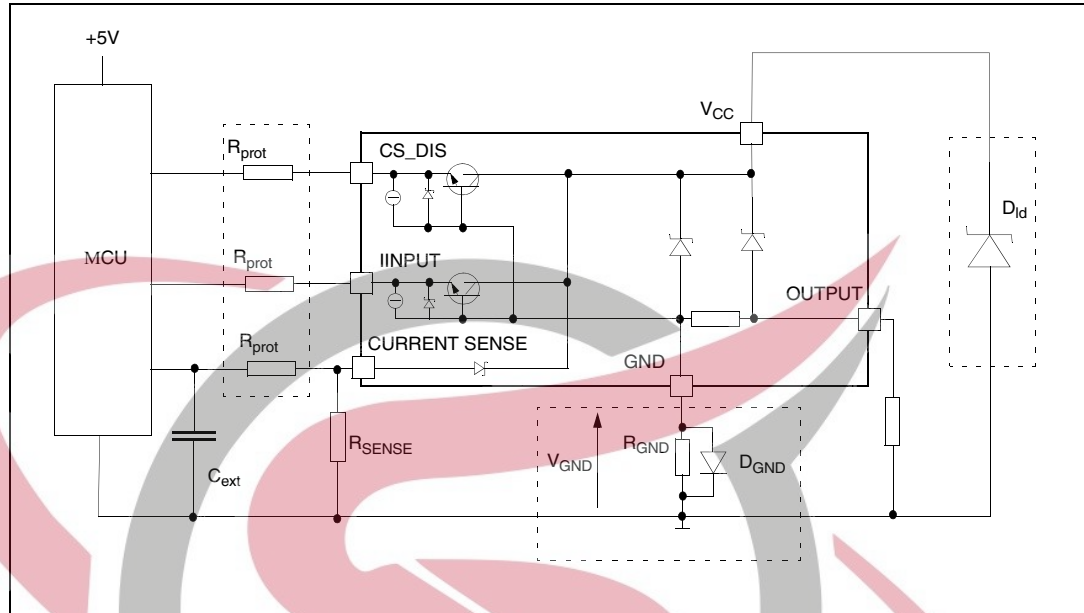

Figure 31. CS\_DIS low level voltage



### 3 Application information

Figure 32. Application schematic



Note: Channel 2, 3, 4 have the same internal circuit as channel 1.

#### 3.1 GND protection network against reverse battery

This section provides two solutions for implementing a ground protection network against reverse battery.

##### 3.1.1 Solution 1: resistor in the ground line (R<sub>GND</sub> only)

This can be used with any type of load.

The following is an indication on how to dimension the R<sub>GND</sub> resistor.

1.  $R_{GND} \leq 600 \text{ mV} / (I_{S(on)max})$ .
2.  $R_{GND} \geq (-V_{CC}) / (-I_{GND})$

where  $-I_{GND}$  is the DC reverse ground pin current and can be found in the absolute maximum rating section of the device datasheet.

Power Dissipation in R<sub>GND</sub> (when  $V_{CC} < 0$ : during reverse battery situations) is:

**Equation 1**

$$P_D = (-V_{CC})^2 / R_{GND}$$



This resistor can be shared amongst several different HSDs. Please note that the value of this resistor should be calculated with formula (1) where  $I_{S(ON)max}$  becomes the sum of the maximum on-state currents of the different devices.

Please note that if the microprocessor ground is not shared by the device ground then the  $R_{GND}$  will produce a shift ( $I_{S(ON)max} * R_{GND}$ ) in the input thresholds and the status output values. This shift will vary depending on how many devices are on in the case of several high side drivers sharing the same  $R_{GND}$ .

If the calculated power dissipation leads to a large resistor or several devices have to share the same resistor then ST suggests to utilize [Section 3.1.2: Solution 2: diode \(DGND\) in the ground line](#).

### 3.1.2 Solution 2: diode ( $D_{GND}$ ) in the ground line

A resistor ( $R_{GND} = 1 \text{ k}\Omega$ ) should be inserted in parallel to  $D_{GND}$  if the device drives an inductive load.

This small signal diode can be safely shared amongst several different HSDs. Also in this case, the presence of the ground network will produce a shift ( $\approx 600\text{mV}$ ) in the input threshold and in the status output values if the microprocessor ground is not common to the device ground. This shift will not vary if more than one HSD shares the same diode/resistor network.

## 3.2 Load dump protection

$D_{ld}$  is necessary (voltage transient suppressor) if the load dump peak voltage exceeds the  $V_{CC}$  max DC rating. The same applies if the device is subject to transients on the  $V_{CC}$  line that are greater than the ones shown in the ISO 7637-2: 2004(E) table.

## 3.3 MCU I/Os protection

If a ground protection network is used and negative transients are present on the  $V_{CC}$  line, the control pins will be pulled negative. ST suggests to insert a resistor ( $R_{prot}$ ) in line to prevent the microcontroller I/O pins to latch-up.

The value of these resistors is a compromise between the leakage current of microcontroller and the current required by the HSD I/Os (Input levels compatibility) with the latch-up limit of microcontroller I/Os.

### Equation 2

$$-V_{CCpeak}/I_{latchup} \leq R_{prot} \leq (V_{OH\mu C} - V_{IH} - V_{GND}) / I_{IHmax}$$

Calculation example:

For  $V_{CCpeak} = -100 \text{ V}$  and  $I_{latchup} \geq 20 \text{ mA}$ ;  $V_{OH\mu C} \geq 4.5 \text{ V}$

$$5 \text{ k}\Omega \leq R_{prot} \leq 180 \text{ k}\Omega.$$

Recommended values:  $R_{prot} = 10 \text{ k}\Omega$ ,  $C_{EXT} = 10 \text{ nF}$ .

### 3.4 Current sense and diagnostic

The current sense pin performs a double function (see *Figure 33: Current sense and diagnostic*):

- **Current mirror of the load current in normal operation**, delivering a current proportional to the load one according to a known ratio  $K_x$ .  
The current  $I_{SENSE}$  can be easily converted to a voltage  $V_{SENSE}$  by means of an external resistor  $R_{SENSE}$ . Linearity between  $I_{OUT}$  and  $V_{SENSE}$  is ensured up to 5V minimum (see parameter  $V_{SENSE}$  in *Table 9: Current sense (8 V <  $V_{CC}$  < 18 V)*). The current sense accuracy depends on the output current (refer to current sense electrical characteristics *Table 9: Current sense (8 V <  $V_{CC}$  < 18 V)*).
- **Diagnostic flag in fault conditions**, delivering a fixed voltage  $V_{SENSEH}$  up to a maximum current  $I_{SENSEH}$  in case of the following fault conditions (refer to *Truth table*):
  - Power limitation activation
  - Overtemperature
  - Short to  $V_{CC}$  in off-state
  - Open-load in off-state with additional external components.

A logic level high on CS\_DIS pin sets at the same time all the current sense pins of the device in a high impedance state, thus disabling the current monitoring and diagnostic detection. This feature allows multiplexing of the microcontroller analog inputs by sharing of sense resistance and ADC line among different devices.

**Figure 33. Current sense and diagnostic**

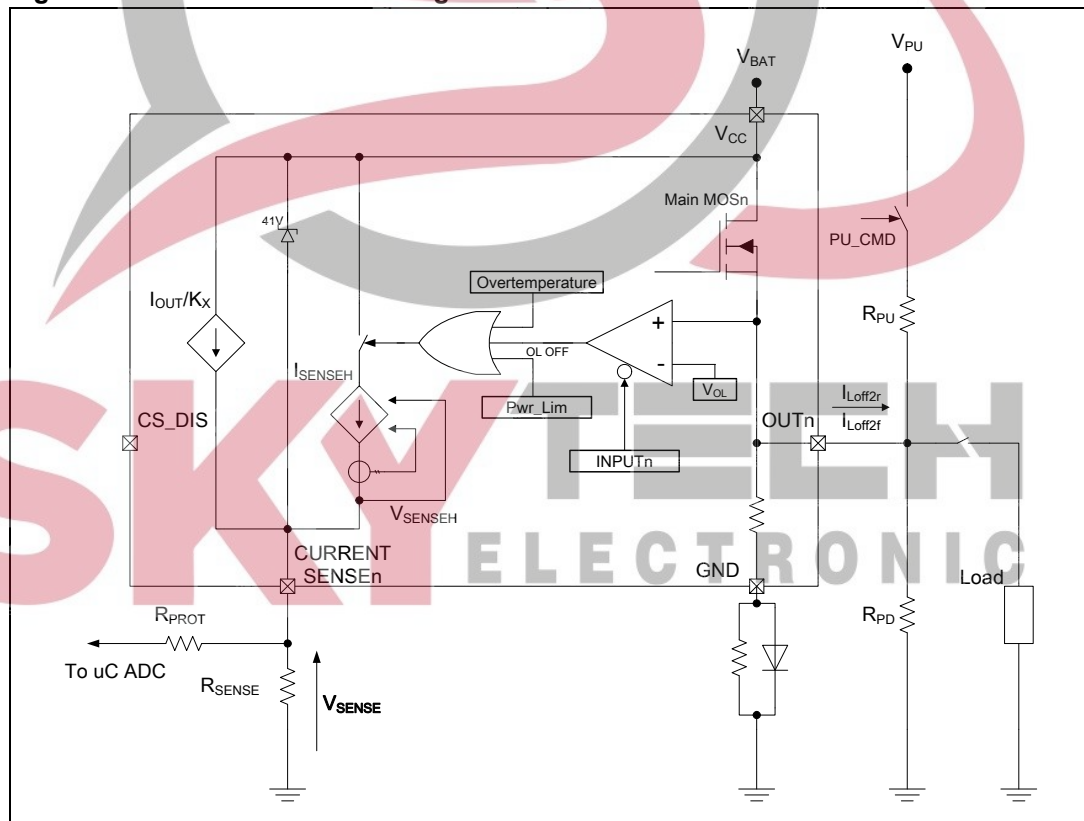

### 3.4.1 Short to $V_{CC}$ and off-state open-load detection

#### Short to $V_{CC}$

A short circuit between  $V_{CC}$  and output is indicated by the relevant current sense pin set to  $V_{SENSEH}$  during the device off-state. Small or no current is delivered by the current sense during the on-state depending on the nature of the short circuit.

#### Off-state open-load with external circuitry

Detection of an open-load in off mode requires an external pull-up resistor  $R_{PU}$  connecting the output to a positive supply voltage  $V_{PU}$ .

It is preferable  $V_{PU}$  to be switched off during the module standby mode in order to avoid the overall standby current consumption to increase in normal conditions, i.e. when load is connected.

An external pull down resistor  $R_{PD}$  connected between output and GND is mandatory to avoid misdetection in case of floating outputs in off-state (see [Figure 33: Current sense and diagnostic](#)).

$R_{PD}$  must be selected in order to ensure  $V_{OUT} < V_{OLmin}$  unless pulled up by the external circuitry:

#### Equation 3

$$V_{OUT}|_{Pull-up\_OFF} = R_{PD} \cdot I_{L(off)2f} < V_{OLmin} = 2V$$

$R_{PD} \leq 22 \text{ k}\Omega$  is recommended.

For proper open-load detection in off-state, the external pull-up resistor must be selected according to the following formula:

#### Equation 4

$$V_{OUT}|_{Pull-up\_ON} = \frac{R_{PD} \cdot V_{PU} - R_{PU} \cdot R_{PD} \cdot I_{L(off)2r}}{R_{PU} + R_{PD}} > V_{OLmax} = 4V$$

For the values of  $V_{OLmin}$ ,  $V_{OLmax}$ ,  $I_{L(off)2r}$  and  $I_{L(off)2f}$  see [Table 10: Open-load detection \( \$8V < V\_{CC} < 18V\$ \)](#).

### 3.5 Maximum demagnetization energy ( $V_{CC} = 13.5\text{ V}$ )

Figure 34. Maximum turn-off current versus inductance (for each channel)

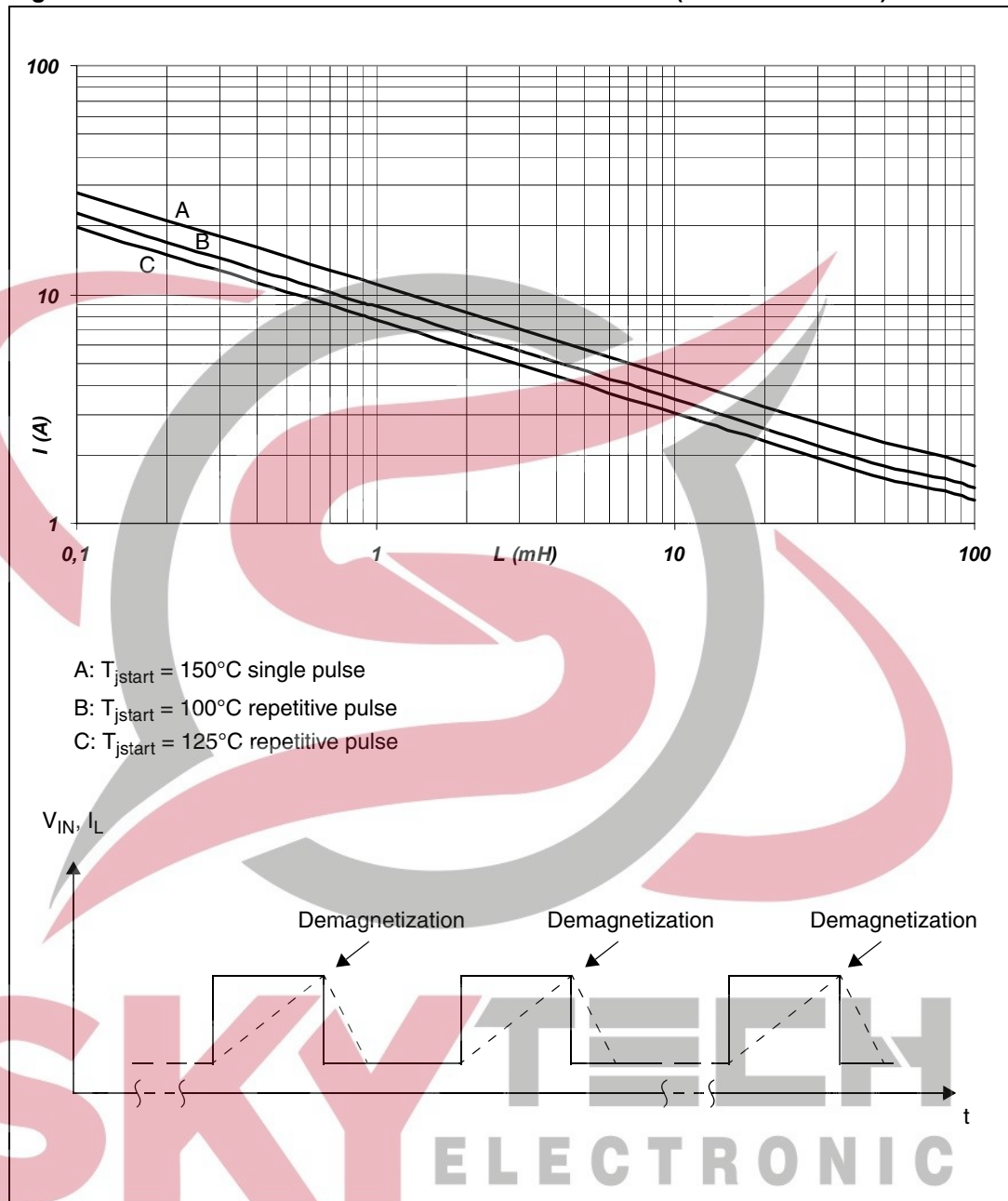

Note: Values are generated with  $R_L = 0\Omega$   
 In case of repetitive pulses,  $T_{jstart}$  (at beginning of each demagnetization) of every pulse must not exceed the temperature specified above for curves A and B.

## 4 Package and PC board thermal data

### 4.1 PowerSSO-24 thermal data

Figure 35. PowerSSO-24 PC board

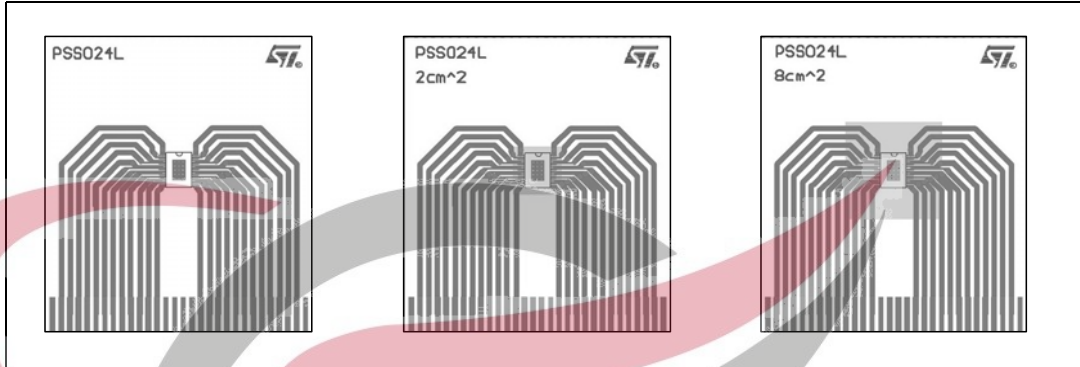

Note: *Layout condition of  $R_{th}$  and  $Z_{th}$  measurements (PCB: Double layer, Thermal Vias, FR4 area = 77 mm x 86 mm, PCB thickness = 1.6 mm, Cu thickness = 70  $\mu$ m (front and back side), Copper areas: from minimum pad lay-out to 8 cm<sup>2</sup>).*

Figure 36.  $R_{thj-amb}$  vs PCB copper area in open box free air condition (one channel ON)

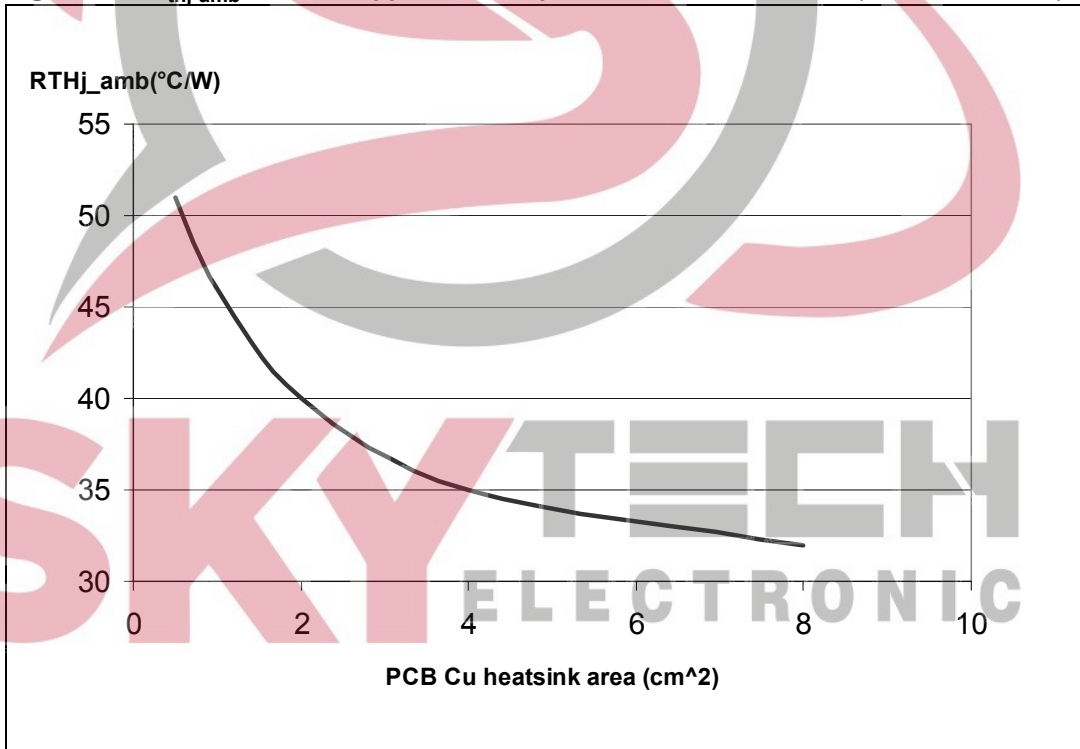

Figure 37. PowerSSO-24 thermal impedance junction ambient single pulse (one channel ON)

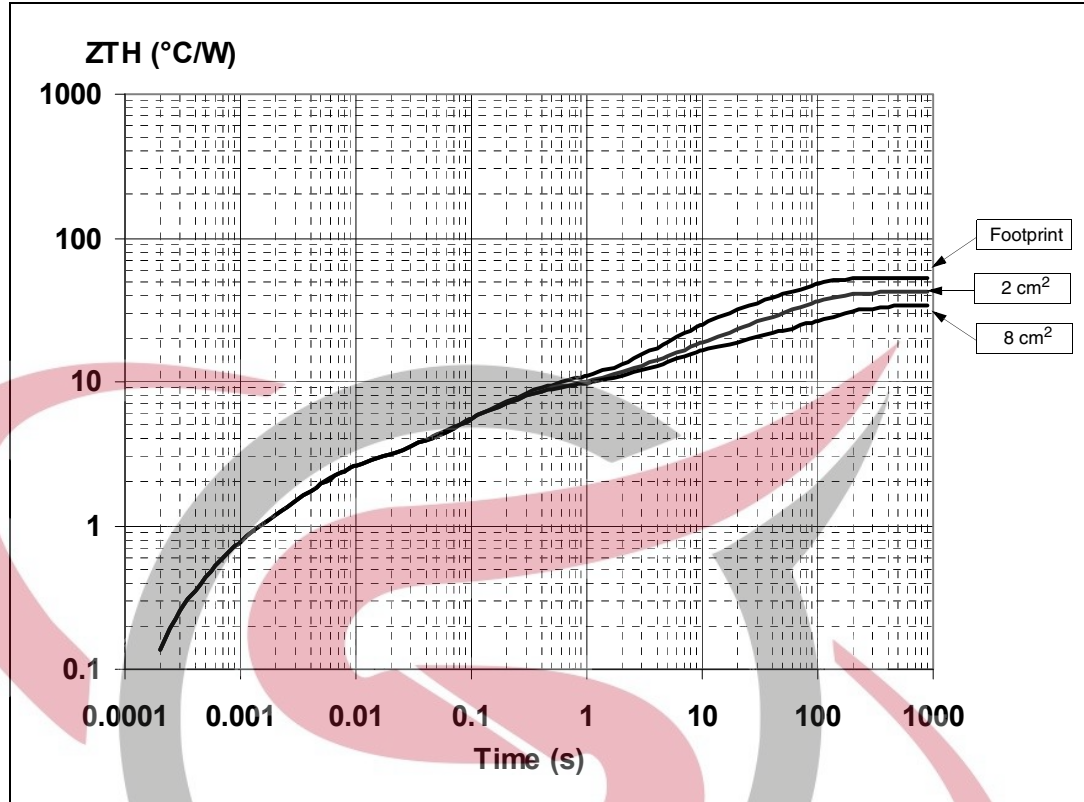
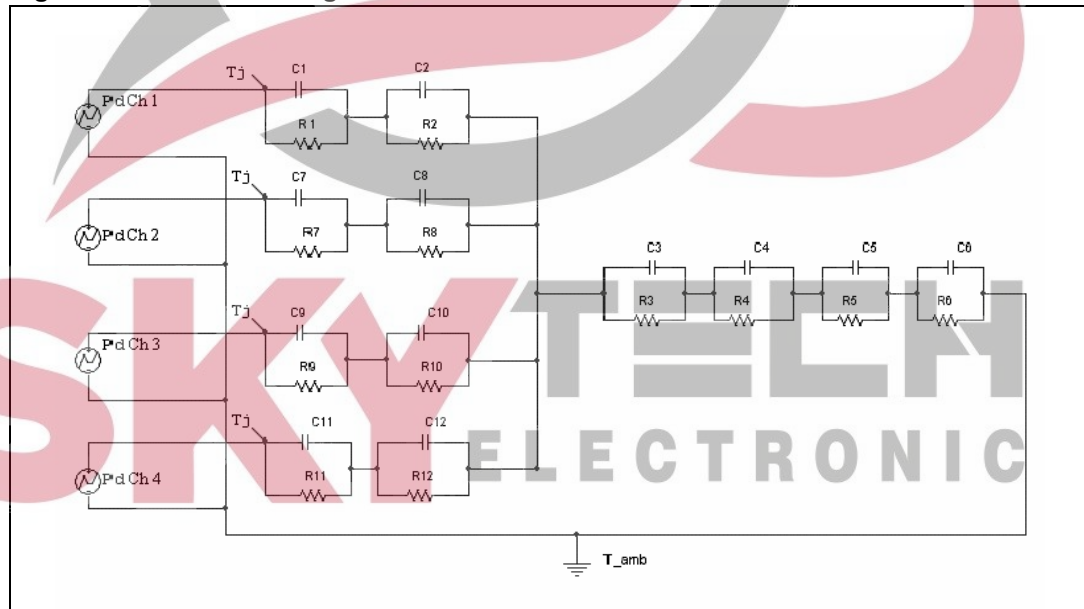

Figure 38. Thermal fitting model of a double channel HSD in PowerSSO-24



Note: The fitting model is a simplified thermal tool and is valid for transient evolutions where the embedded protections (power limitation or thermal cycling during thermal shutdown) are not triggered.

## Equation 5: pulse calculation formula

$$Z_{TH\delta} = R_{TH} \cdot \delta + Z_{THtp}(1 - \delta)$$

where  $\delta = t_p/T$

Table 15. Thermal parameters

Area/island (cm <sup>2</sup> )	Footprint	2	8
R1 = R7 = R9 = R11 (°C/W)	0.4		
R2 = R8 = R10 = R12 (°C/W)	2		
R3 (°C/W)	6		
R4 (°C/W)	7.7		
R5 (°C/W)	9	9	8
R6 (°C/W)	28	17	10
C1 = C7 = C9 = C11 (W.s/°C)	0.001		
C2 = C8 = C10 = C12 (W.s/°C)	0.0022		
C3 (W.s/°C)	0.025		
C4 (W.s/°C)	0.75		
C5 (W.s/°C)	1	4	9
C6 (W.s/°C)	2.2	5	17

**SKY**TECH  
ELECTRONIC

## 5 Package and packing information

### 5.1 ECOPACK®

In order to meet environmental requirements, ST offers these devices in different grades of ECOPACK® packages, depending on their level of environmental compliance. ECOPACK® specifications, grade definitions and product status are available at: [www.st.com](http://www.st.com).

ECOPACK® is an ST trademark.

### 5.2 PowerSSO-24 mechanical data

Figure 39. PowerSSO-24 package dimensions

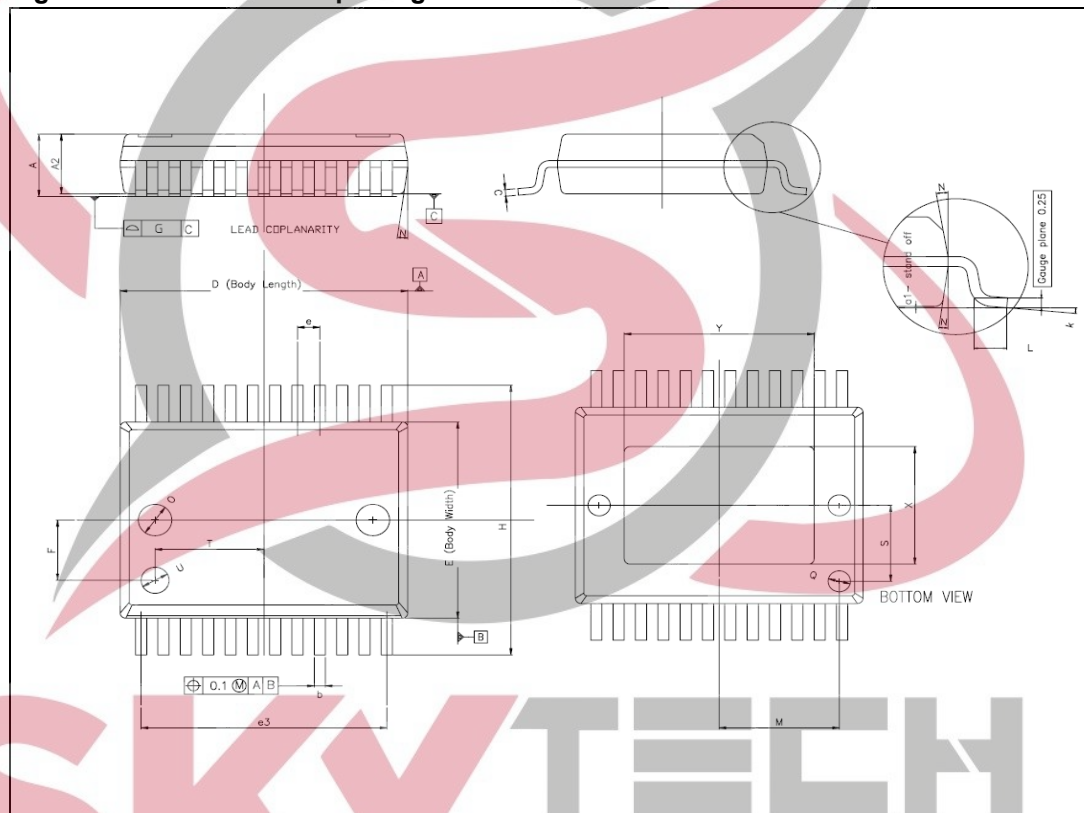



Table 16. PowerSSO-24 mechanical data

Symbol	Millimeters		
	Min.	Typ.	Max.
A			2.45
A2	2.15		2.35
a1	0		0.1
b	0.33		0.51
c	0.23		0.32
D	10.10		10.50
E	7.40		7.60
e		0.8	
e3		8.8	
F		2.3	
G			0.1
H	10.1		10.5
h			0.4
k	0°		8°
L	0.55		0.85
O		1.2	
Q		0.8	
S		2.9	
T		3.65	
U		1.0	
N			10°
X	4.1		4.7
Y	6.5		7.1

### 5.3 Packing information

Figure 40. PowerSSO-24 tube shipment (no suffix)

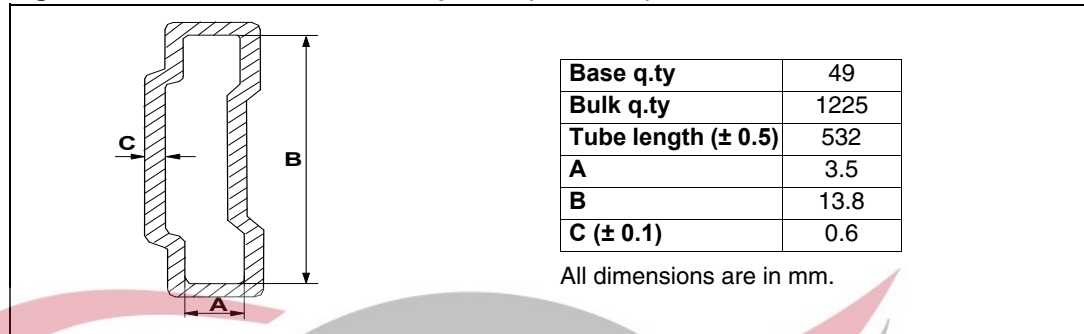
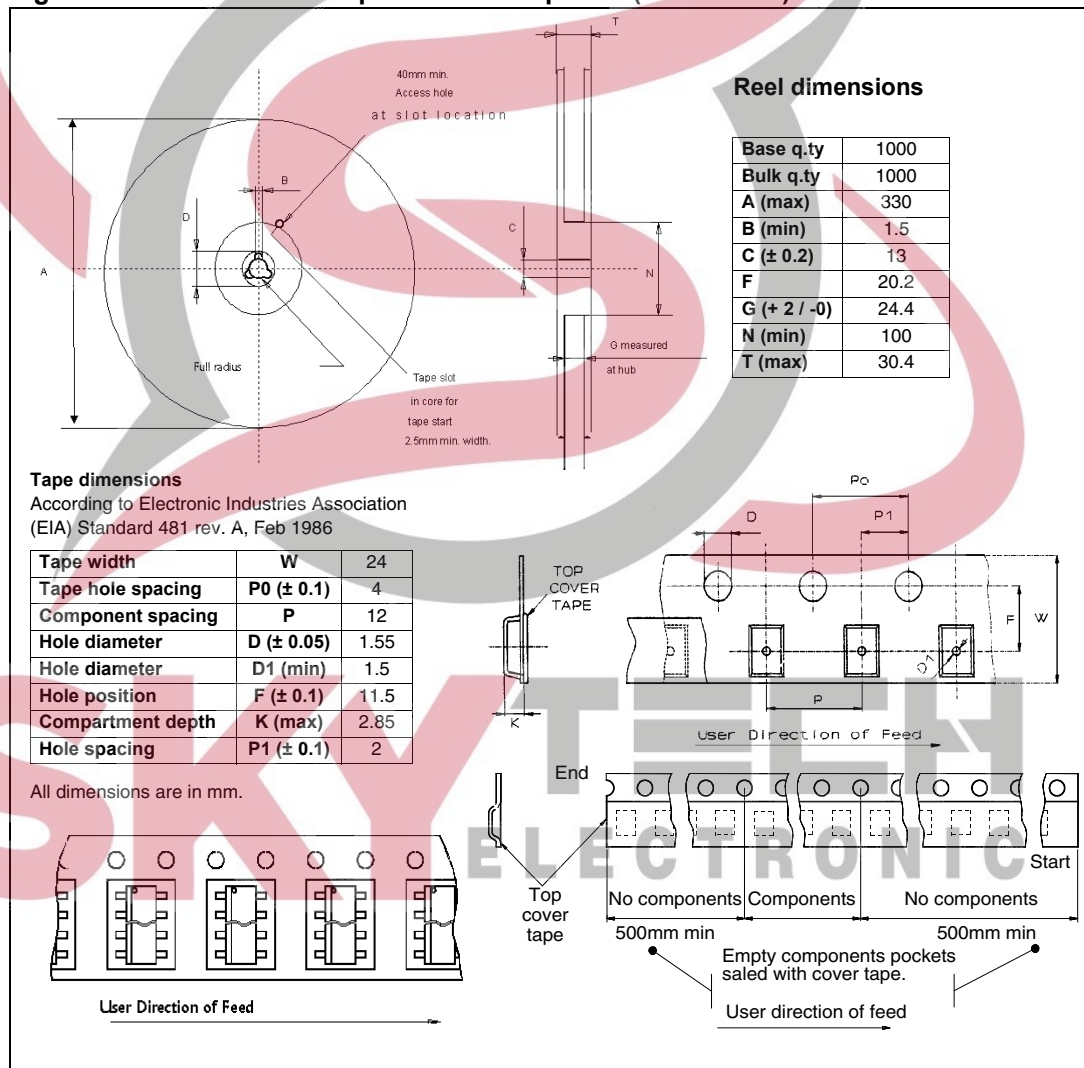

Figure 41. PowerSSO-24 tape and reel shipment (suffix "TR")



## 6 Order codes

Table 17. Device summary

Package	Order codes	
	Tube	Tape and reel
PowerSSO-24	VNQ5E050AK-E	VNQ5E050AKTR-E



## 7 Revision history

**Table 18. Document revision history**

Date	Revision	Changes
06-Jun-2007	1	Initial release.
27-Mar-2008	2	<p>Updated <a href="#">Table 9: Current sense (8 V &lt; V<sub>CC</sub> &lt; 18 V)</a>:</p> <ul style="list-style-type: none"> <li>– added dk1/k1, dk2/k2, dk3/k3 parameters</li> <li>– changed t<sub>DSENSE2H</sub> max value from 300 μs to 250 μs</li> </ul> <p>Updated <a href="#">Table 10: Open-load detection (8V&lt;V<sub>CC</sub>&lt;18V)</a>:</p> <ul style="list-style-type: none"> <li>– added I<sub>L(off2)r</sub>, I<sub>L(off2)f</sub> and td_vol parameters</li> </ul> <p>Added <a href="#">Figure 9.: I<sub>OUT</sub>/I<sub>SENSE</sub> vs I<sub>OUT</sub></a>.</p> <p>Added <a href="#">Figure 10.: Maximum current sense ratio drift vs load current</a></p> <p>Added <a href="#">Section 2.4: Waveforms</a>.</p> <p>Added <a href="#">Section 2.5: Electrical characteristics curves</a>.</p> <p>Updated <a href="#">Section 3: Application information</a>:</p> <ul style="list-style-type: none"> <li>– added <a href="#">Section 3.4: Current sense and diagnostic</a></li> </ul> <p>Updated <a href="#">Section 4: Package and PC board thermal data</a>:</p> <ul style="list-style-type: none"> <li>– added <a href="#">Figure 37.: PowerSSO-24 thermal impedance junction ambient single pulse (one channel ON)</a></li> <li>– added <a href="#">Table 15: Thermal parameters</a>.</li> </ul>
17-Mar-2009	3	Changed <a href="#">Table 16: PowerSSO-24 mechanical data</a>
22-Jun-2009	4	<p><a href="#">Table 16: PowerSSO-24 mechanical data</a>:</p> <ul style="list-style-type: none"> <li>– Changed L (min) value from 6 to 0.55</li> <li>– Changed L (max) value from 1 to 0.85</li> </ul>
22-Jul-2009	5	Updated <a href="#">Figure 39: PowerSSO-24 package dimensions</a> .
26-Oct-2010	6	<p><a href="#">Table 5: Power section</a>:</p> <ul style="list-style-type: none"> <li>– V<sub>USD</sub>: updated minimum value</li> </ul>
20-Sep-2013	7	Updated Disclaimer



**Please Read Carefully:**

Information in this document is provided solely in connection with ST products. STMicroelectronics NV and its subsidiaries ("ST") reserve the right to make changes, corrections, modifications or improvements, to this document, and the products and services described herein at any time, without notice.

All ST products are sold pursuant to ST's terms and conditions of sale.

Purchasers are solely responsible for the choice, selection and use of the ST products and services described herein, and ST assumes no liability whatsoever relating to the choice, selection or use of the ST products and services described herein.

No license, express or implied, by estoppel or otherwise, to any intellectual property rights is granted under this document. If any part of this document refers to any third party products or services it shall not be deemed a license grant by ST for the use of such third party products or services, or any intellectual property contained therein or considered as a warranty covering the use in any manner whatsoever of such third party products or services or any intellectual property contained therein.

**UNLESS OTHERWISE SET FORTH IN ST'S TERMS AND CONDITIONS OF SALE ST DISCLAIMS ANY EXPRESS OR IMPLIED WARRANTY WITH RESPECT TO THE USE AND/OR SALE OF ST PRODUCTS INCLUDING WITHOUT LIMITATION IMPLIED WARRANTIES OF MERCHANTABILITY, FITNESS FOR A PARTICULAR PURPOSE (AND THEIR EQUIVALENTS UNDER THE LAWS OF ANY JURISDICTION), OR INFRINGEMENT OF ANY PATENT, COPYRIGHT OR OTHER INTELLECTUAL PROPERTY RIGHT.**

**ST PRODUCTS ARE NOT DESIGNED OR AUTHORIZED FOR USE IN: (A) SAFETY CRITICAL APPLICATIONS SUCH AS LIFE SUPPORTING, ACTIVE IMPLANTED DEVICES OR SYSTEMS WITH PRODUCT FUNCTIONAL SAFETY REQUIREMENTS; (B) AERONAUTIC APPLICATIONS; (C) AUTOMOTIVE APPLICATIONS OR ENVIRONMENTS, AND/OR (D) AEROSPACE APPLICATIONS OR ENVIRONMENTS. WHERE ST PRODUCTS ARE NOT DESIGNED FOR SUCH USE, THE PURCHASER SHALL USE PRODUCTS AT PURCHASER'S SOLE RISK, EVEN IF ST HAS BEEN INFORMED IN WRITING OF SUCH USAGE, UNLESS A PRODUCT IS EXPRESSLY DESIGNATED BY ST AS BEING INTENDED FOR "AUTOMOTIVE, AUTOMOTIVE SAFETY OR MEDICAL" INDUSTRY DOMAINS ACCORDING TO ST PRODUCT DESIGN SPECIFICATIONS. PRODUCTS FORMALLY ESCC, QML OR JAN QUALIFIED ARE DEEMED SUITABLE FOR USE IN AEROSPACE BY THE CORRESPONDING GOVERNMENTAL AGENCY.**

Resale of ST products with provisions different from the statements and/or technical features set forth in this document shall immediately void any warranty granted by ST for the ST product or service described herein and shall not create or extend in any manner whatsoever, any liability of ST.

ST and the ST logo are trademarks or registered trademarks of ST in various countries.

Information in this document supersedes and replaces all information previously supplied.

The ST logo is a registered trademark of STMicroelectronics. All other names are the property of their respective owners.

© 2013 STMicroelectronics - All rights reserved

STMicroelectronics group of companies

Australia - Belgium - Brazil - Canada - China - Czech Republic - Finland - France - Germany - Hong Kong - India - Israel - Italy - Japan - Malaysia - Malta - Morocco - Philippines - Singapore - Spain - Sweden - Switzerland - United Kingdom - United States of America

[www.st.com](http://www.st.com)